

DENNIS KAST

SCHRANK - ARMOIRE - WARDROBE

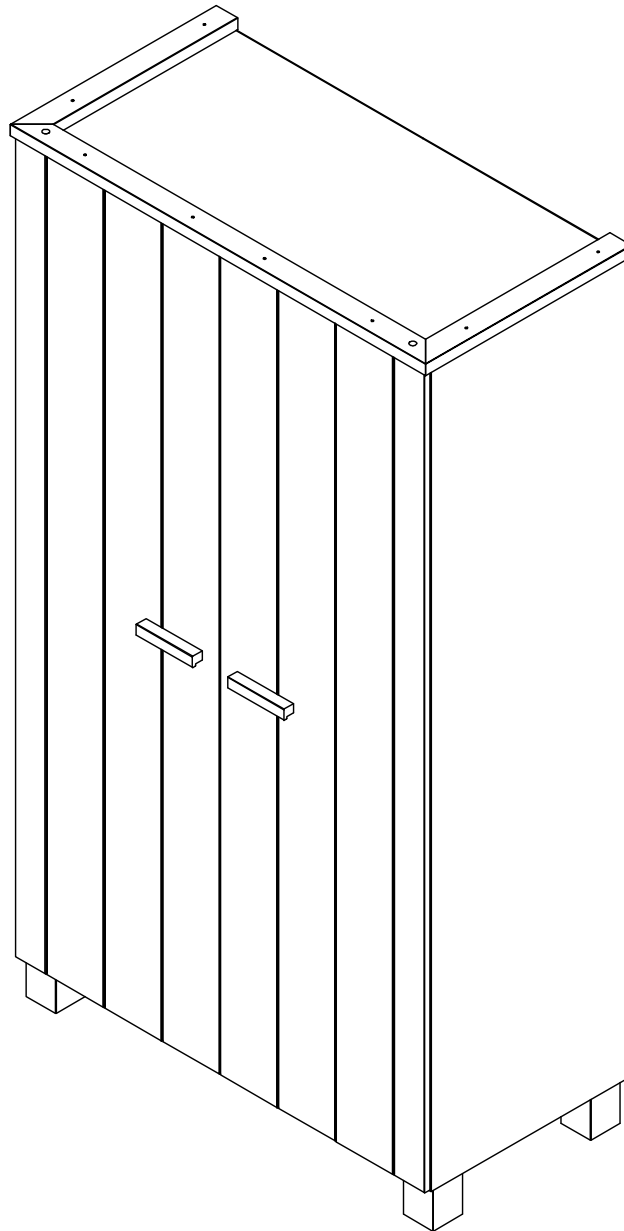

wood MADE BY

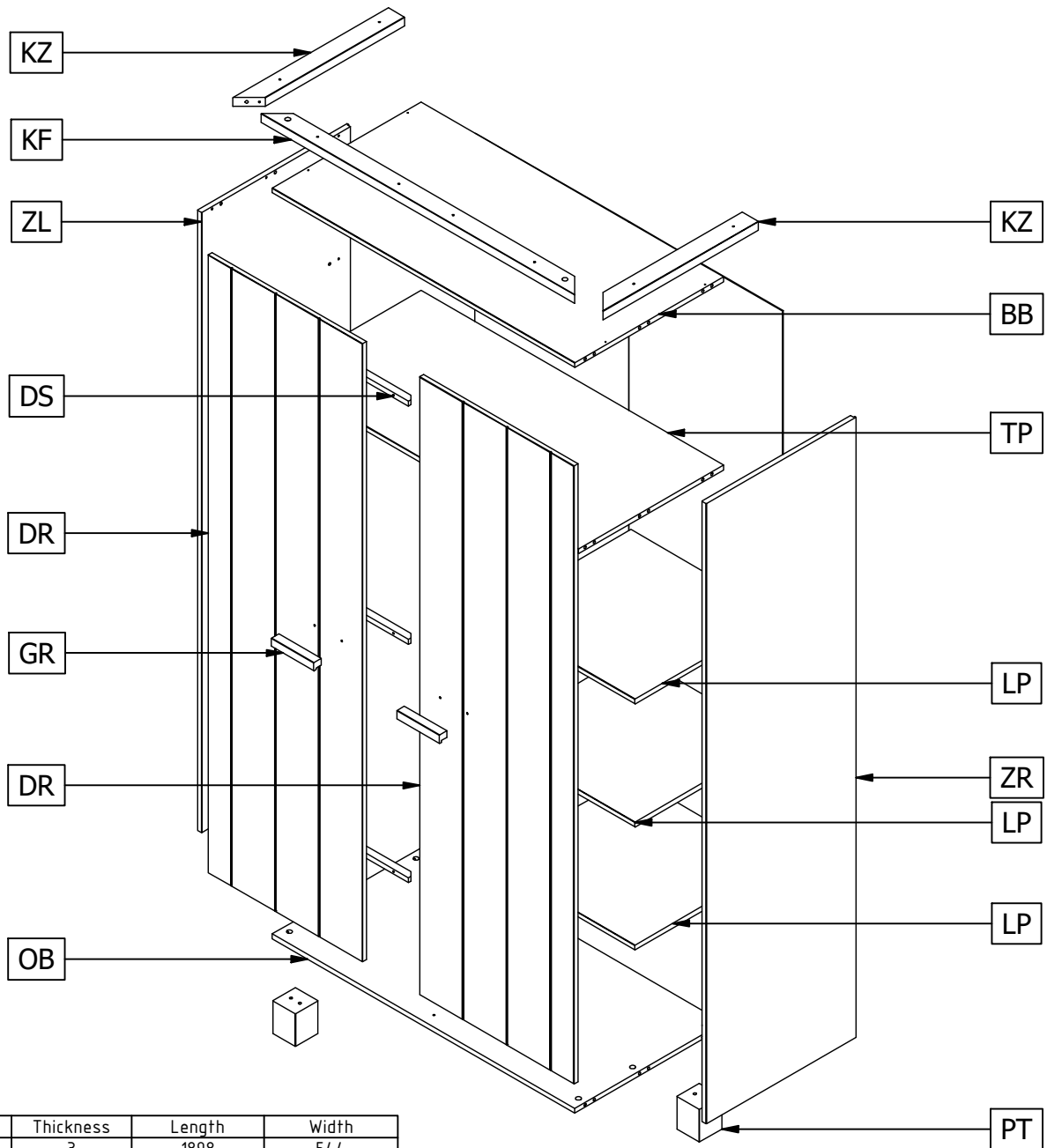

Qty	Code	Thickness	Length	Width
2	AK	3	1898	544
1	BB	15	1070	526
2	DR	15	1894	546
2	DR	15	1894	546
6	DS	15	425	24
2	GR	26	150	26
1	KF	28	1110	58
2	KZ	28	550	58
3	LP	15	527	513
1	OB	15	1070	526
4	PT	80	100	80
1	TP	15	1070	513
1	TS	15	1493	513
1	ZL	15	1900	530
1	ZR	15	1900	530



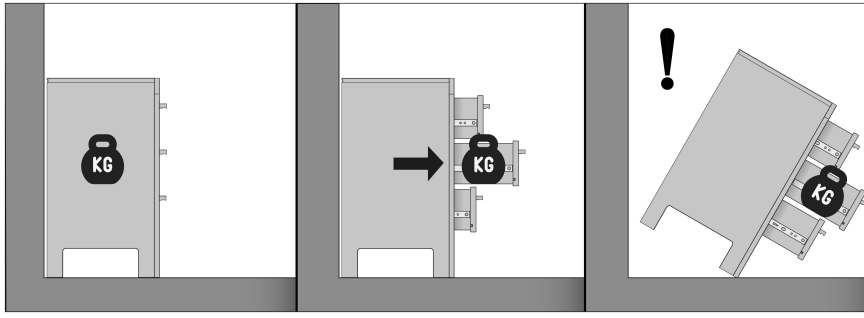

Nederlands

WAARSCHUWING.

Voorkom dat dit meubel omvalt. Meubels die omvallen kunnen ernstig of levensbedreigend letsel veroorzaken. Het meegeleverde kantelbeslag dient daarom BESLIST te worden gebruikt om het meubel te bevestigen aan de muur.

Sta niet toe dat kinderen klimmen op lades, deuren of planken.
Plaats zware voorwerpen altijd onderin.
Zet zware voorwerpen nooit op het meubel.

Norsk

ADVARSEL.

Unngå at dette møbelet faller. Møbler som faller kan forårsake alvorlige eller livstruende skader. Det medleverte beslaget skal derfor ABSOLUTT brukes for å feste møbelet til veggen.

Ikke tillat at barn klatrer på skuffer, dører eller planker.
Plasser tunge objekter alltid nederst.
Sett aldri tunge objekter på møbelet.

Deutsch

WARNHINWEIS.

Verhindern Sie, dass dieses Möbelstück umstürzt. Möbel, die umfallen, können schwere oder lebensbedrohliche Verletzungen verursachen. Zur Befestigung des Möbelstücks an der Wand sollte daher UNBEDINGT die mitgelieferte Kippsicherung verwendet werden.

Erlauben Sie Kindern nicht, auf Schubladen, Türen oder Regale zu klettern.
Stellen Sie schwere Gegenstände nur unten in das Möbelstück.
Stellen Sie niemals schwere Gegenstände auf das Möbelstück.

Français

ATTENTION.

Évitez que le meuble ne bascule. Les meubles qui basculent peuvent être à l'origine de blessures graves ou mortelles. La fixation anti-basculement fournie avec le meuble doit OBLIGATOIREMENT être utilisée pour fixer celui-ci au mur.

Ne laissez pas les enfants grimper sur les tiroirs, portes ou étagères.
Placez toujours les objets lourds dans le bas du meuble.
Ne placez jamais les objets lourds sur le meuble.

English

CAUTION.

Prevent this furniture from falling over. Falling furniture could cause severe or life-threatening injuries. Therefore, the included tip-over restraint HAS to be used to secure the furniture to the wall.

Do not allow children to climb on the drawers, doors or shelves.
Always place heavy objects at the bottom.
Never place heavy objects on top of the furniture.

Svenska

VARNING.

Förhindra att denna möbel välter. Möbler som välter kan orsaka allvarliga eller livshotande skador. Det medföljande tipskyddet MÅSTE därför användas för att förankra möbelen i väggen.

Låt inte barn klättra på lådor, dörrar eller hyllor.
Placera alltid tunga föremål längst ned.
Ställ aldrig tunga föremål på möbelen.

Polski

UWAGA.

Zabezpiecz meble przed przewróceniem. Przewrócenie się mebli może spowodować poważne lub śmiertelne obrażenia ciała. Dlatego załączone ograniczniki przechyli ZDECYDOWANIE powinny zostać wykorzystane do przymocowania mebla do ściany.





Nie pozwalaj dzieciom wspinać się na szuflady, drzwiczki lub półki.
Zawsze umieszczaj ciężkie przedmioty w dolnej części.
Nigdy nie stawiaj na meblu ciężkich przedmiotów.

Español

ADVERTENCIA.

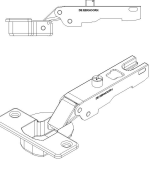
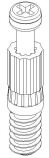
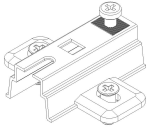
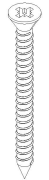
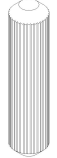
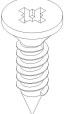
Evite que este mueble se caiga. Los muebles que se caen pueden ocasionar lesiones graves o potencialmente mortales. Por lo tanto, el herraje abatible suministrado debe utilizarse SIN LUGAR A DUDAS para fijar el mueble a la pared.

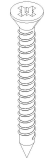
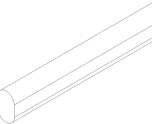
No permita que los niños se suban a los cajones, las puertas o los estantes.
Los objetos pesados siempre deben colocarse en la parte inferior.
Nunca coloque objetos pesados sobre el mueble.

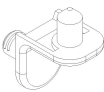
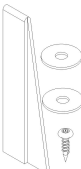
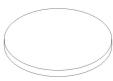
24	Ø15mm	AC000102 	6	Ø35mm 0V	AC000423 
24	24mm	AC000103 	6	2mm	AC000448 
8	3.5x40mm	AC000203 	28	8x35mm	AC000601 
14	4x16mm	AC000204 	1	Glue	AC000607 
22	3.5x35mm	AC000219 	1	L=520mm	AC000902 
75	Ø1.4x25mm	AC000316 			
2		AC000335 			
12	Ø5MM	AC000349 			
1	Safety Strip	AC000356 			
24	Ø14mm	AC000369- 			

1

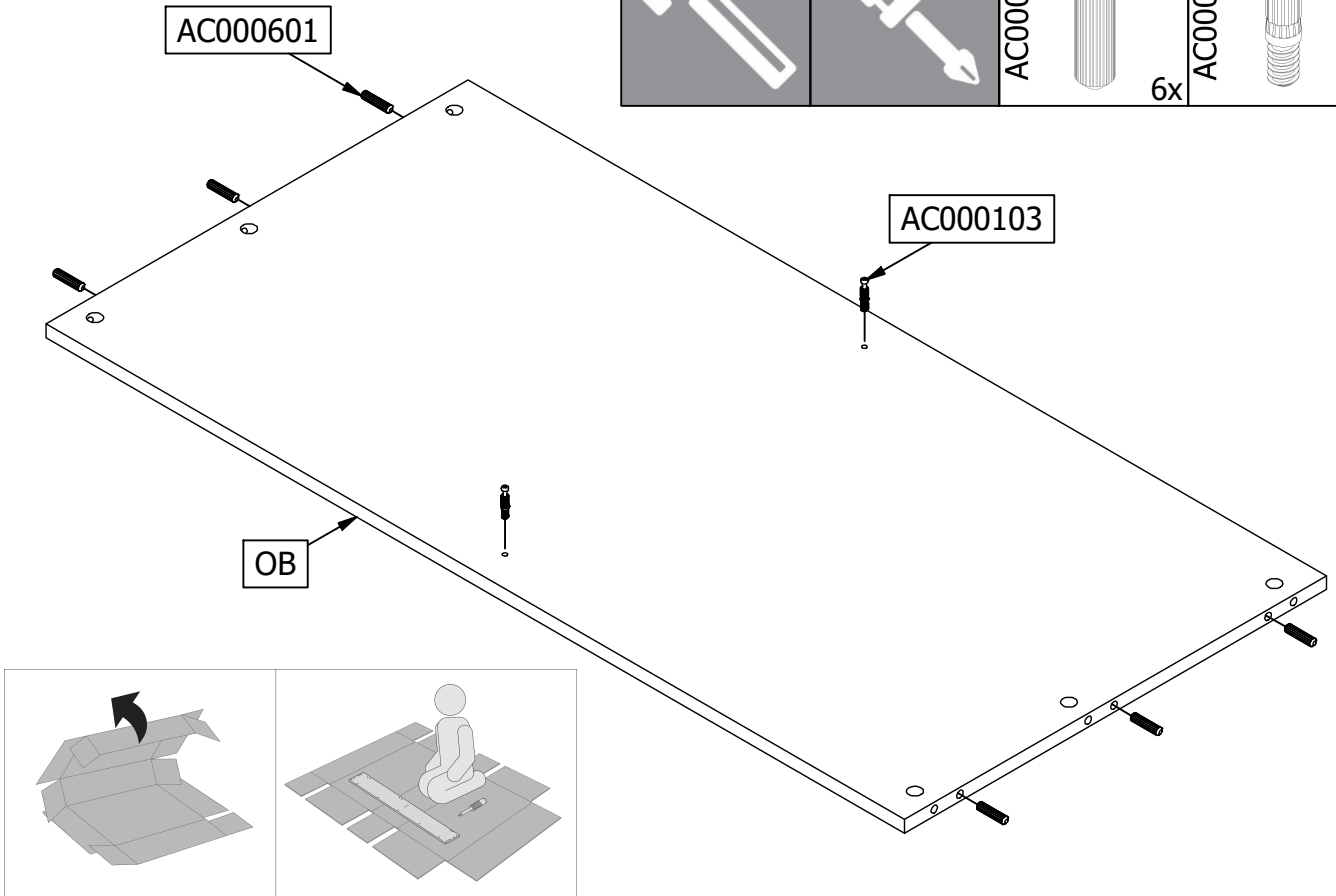
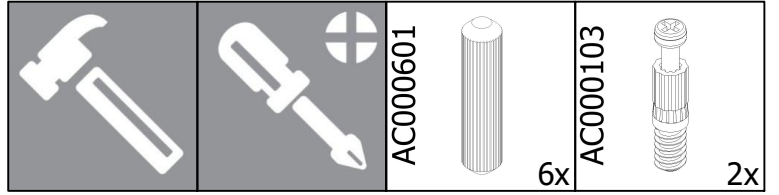

2

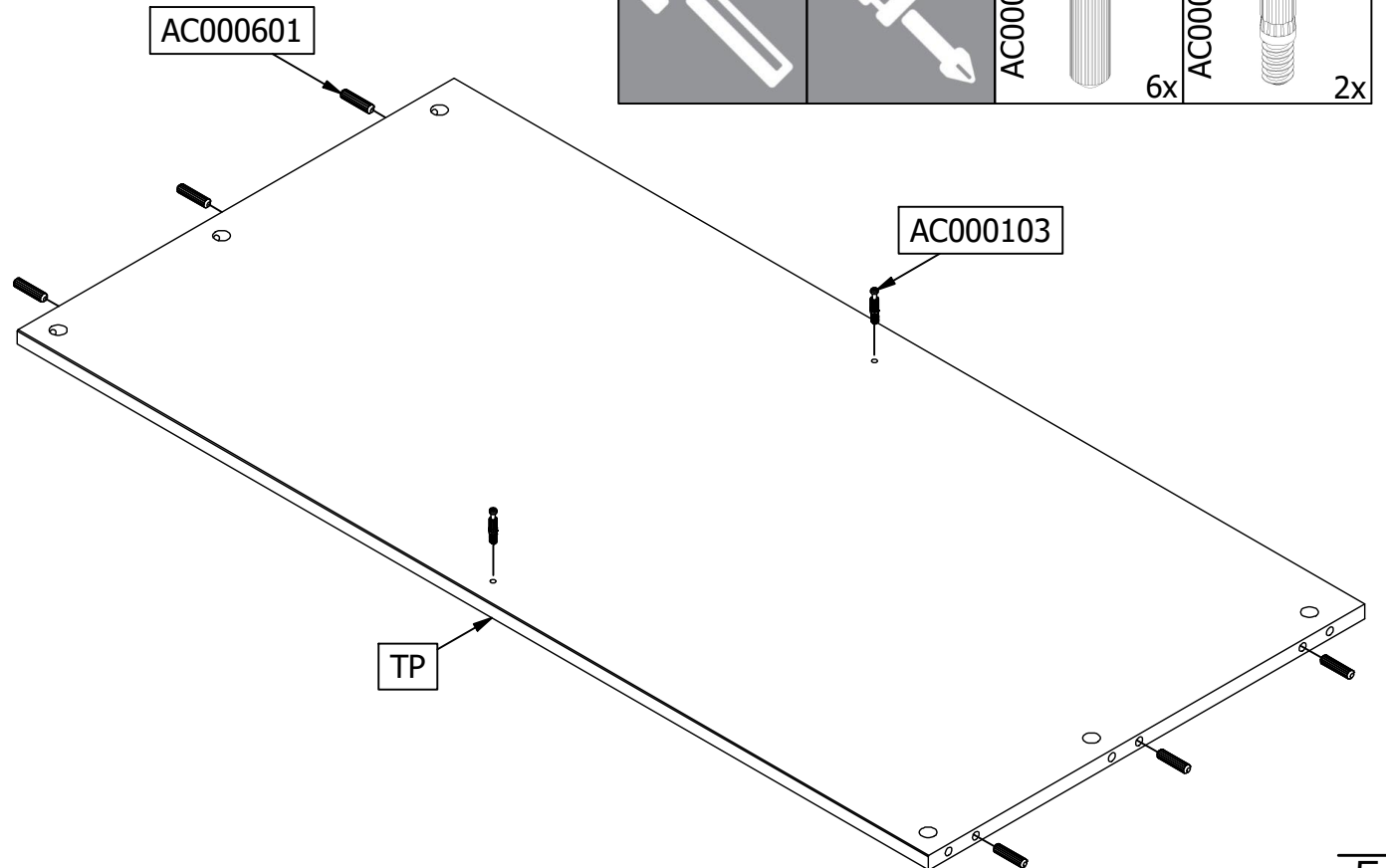
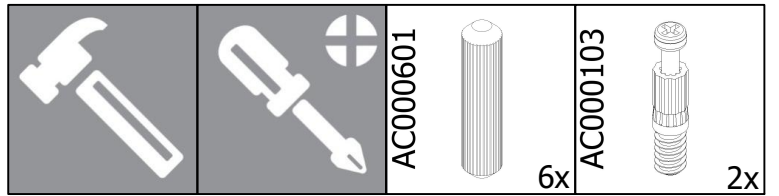

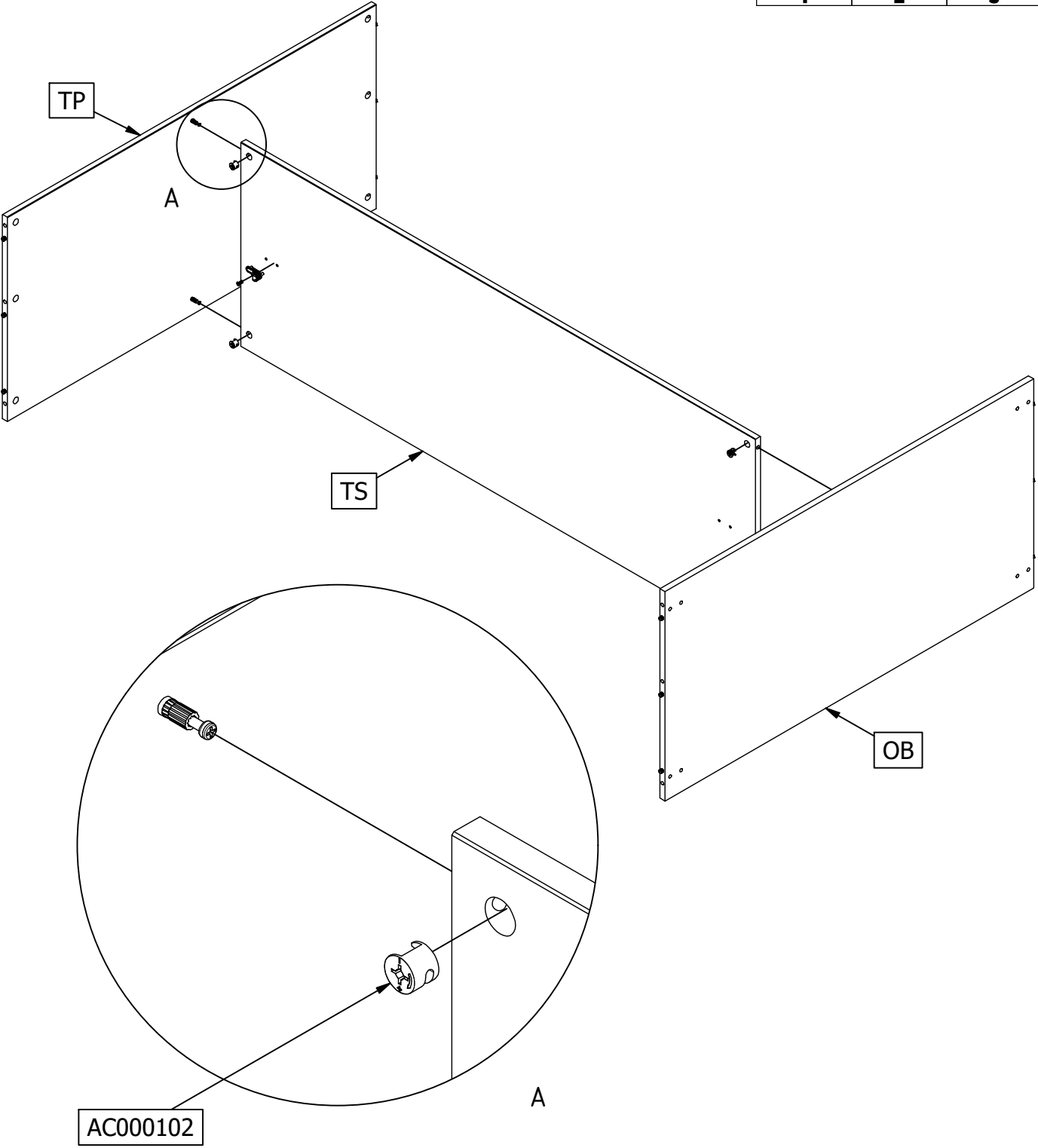
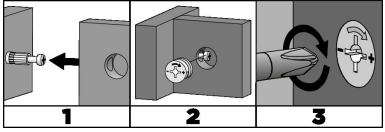
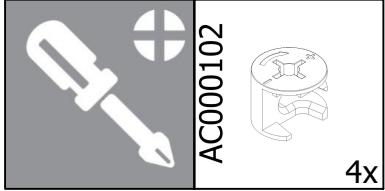

3

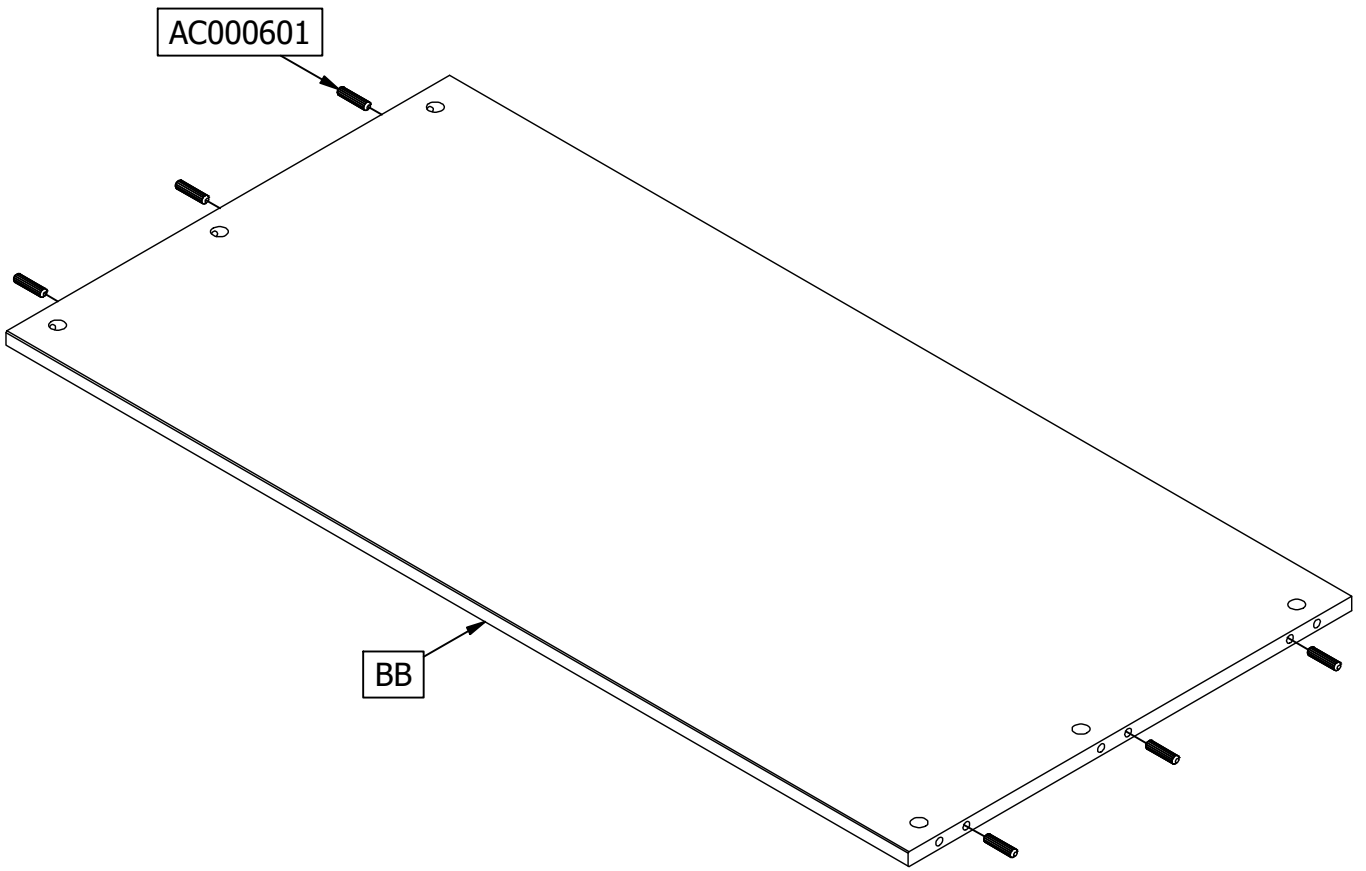
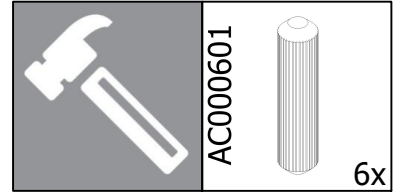

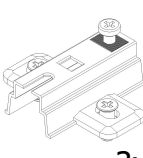
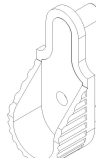

5

AC000103

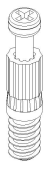
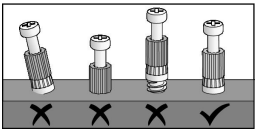
	AC000448		3x	AC000335		1x	AC000204		1x	AC000103		9x
												

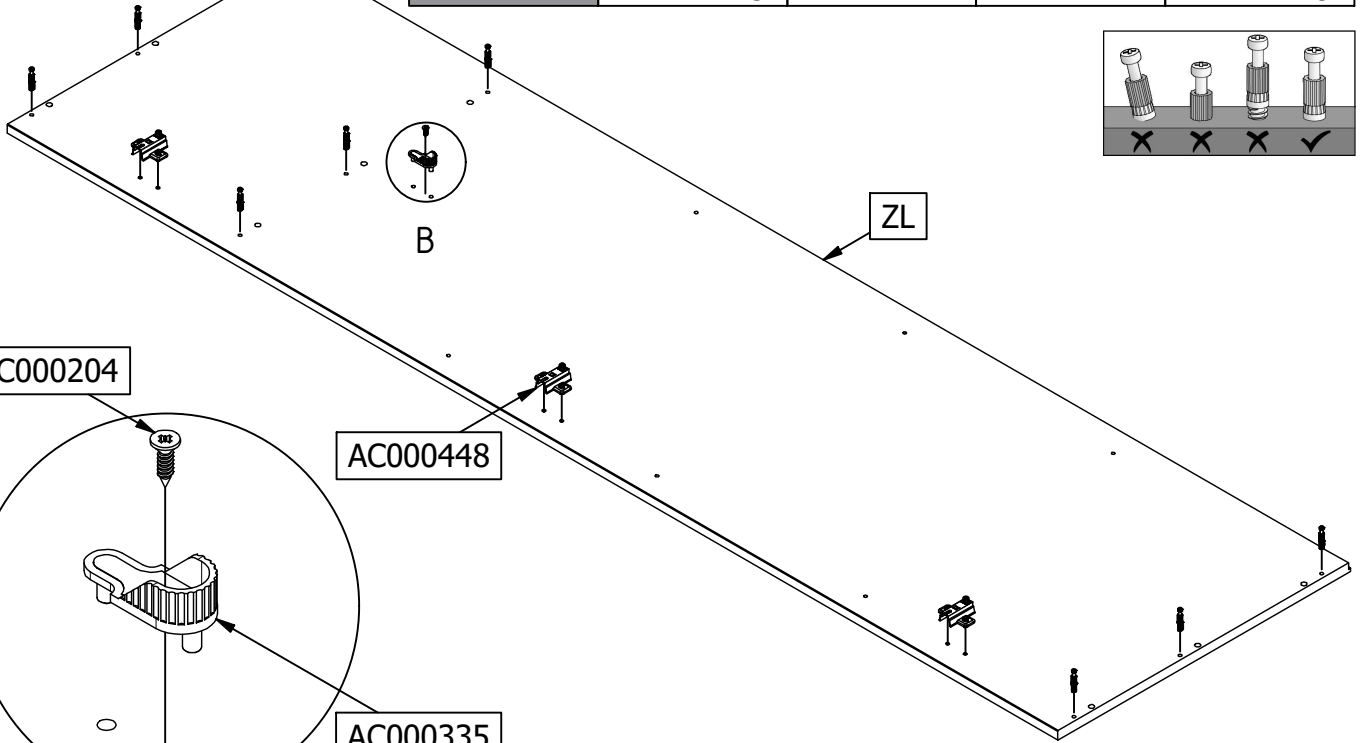

AC000204

AC000448

AC000335

B

ZL

6

AC000103

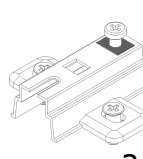
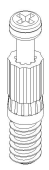
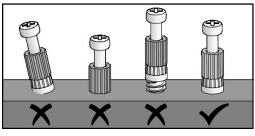
	AC000448		3x	AC000103		9x
						

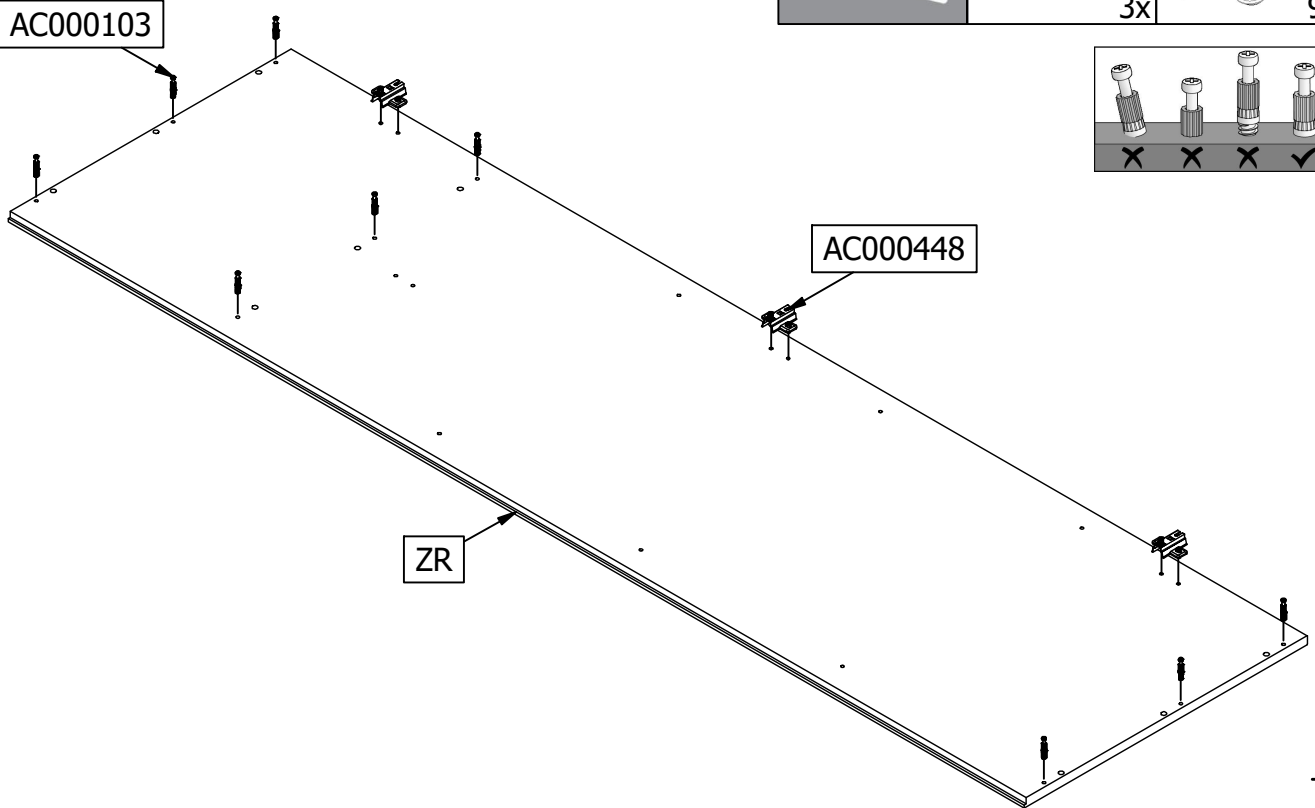

AC000448

ZR

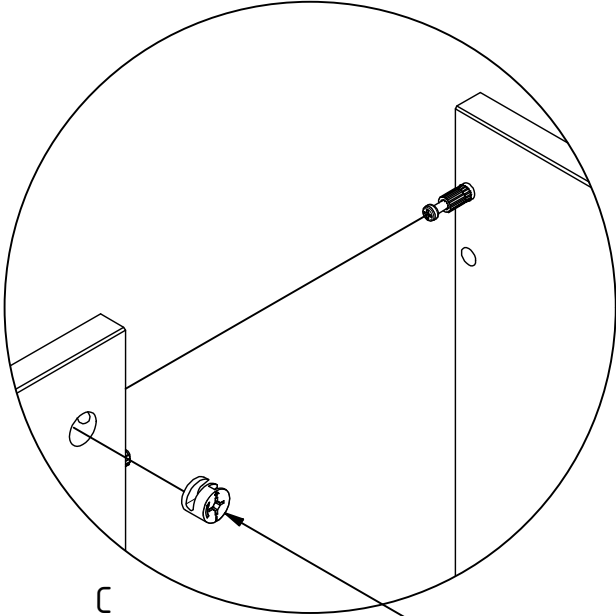
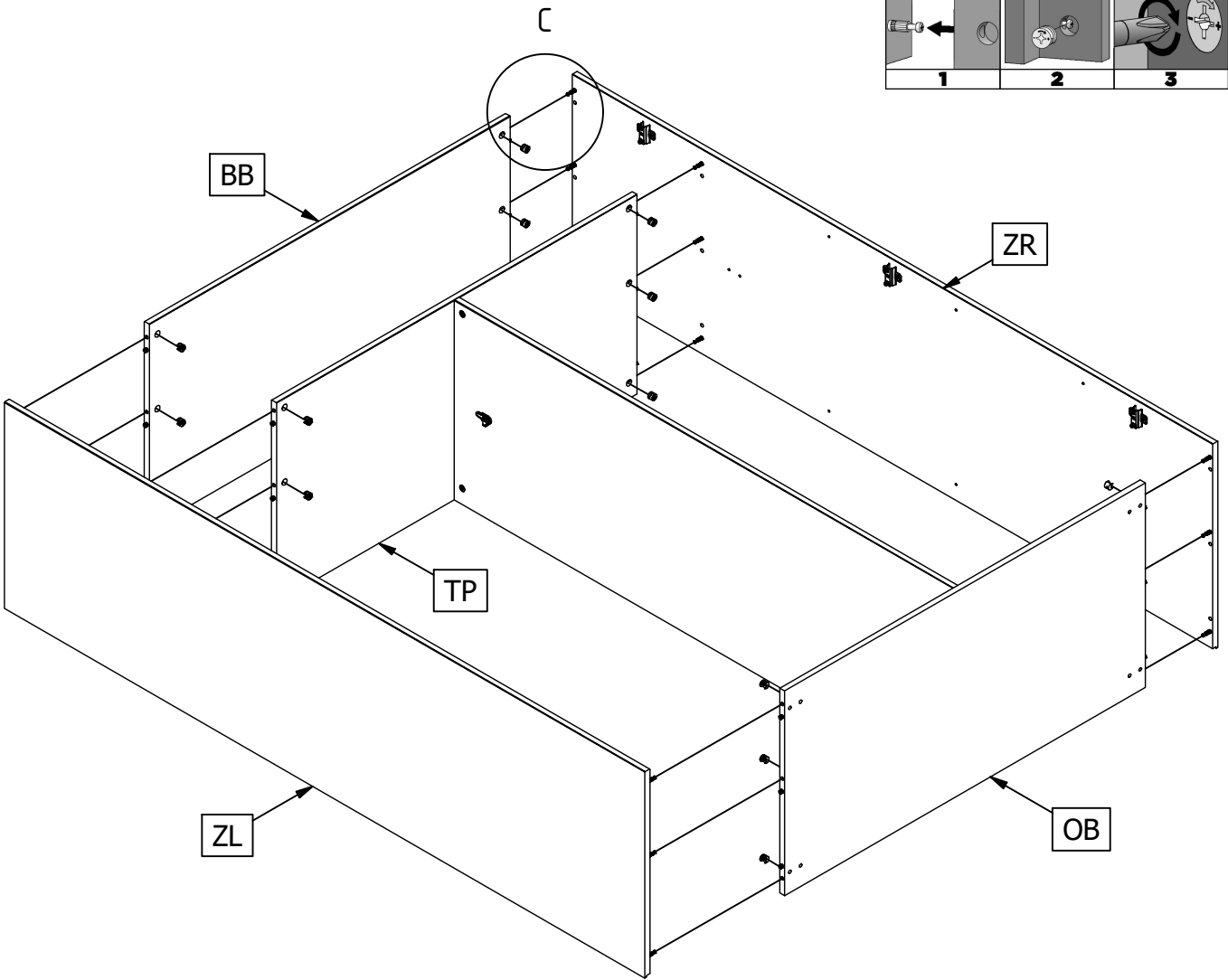
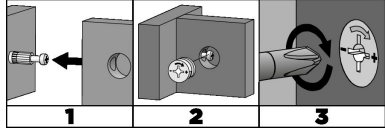
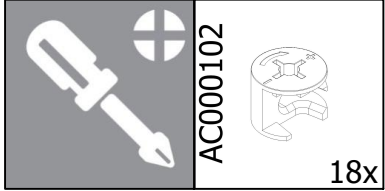

AC000102

8

AC000601

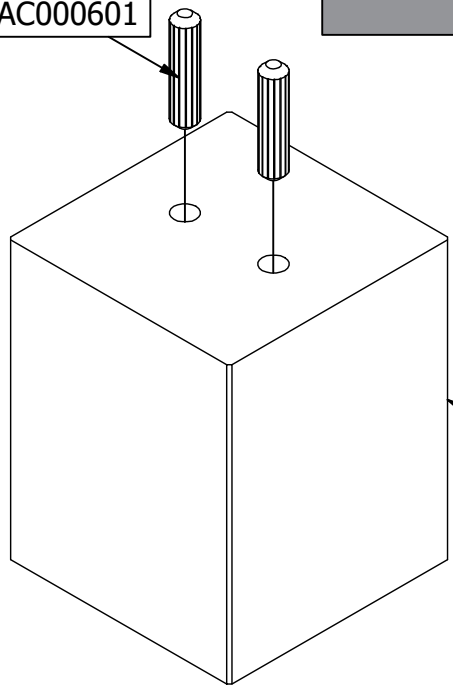

PT

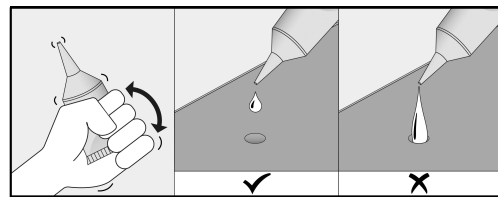
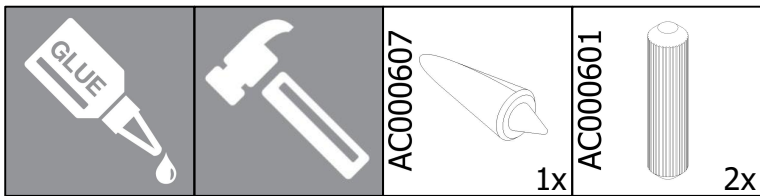

Het gebruik van een klein beetje houtlijm is noodzakelijk voor een goede verbinding
 Für eine stabile Verbindung ist ein bisschen Holzleim erforderlich
 Un peu de colle à bois est nécessaire pour un assemblage solide
 The use of a little wood glue is necessary for proper connection

4x

9

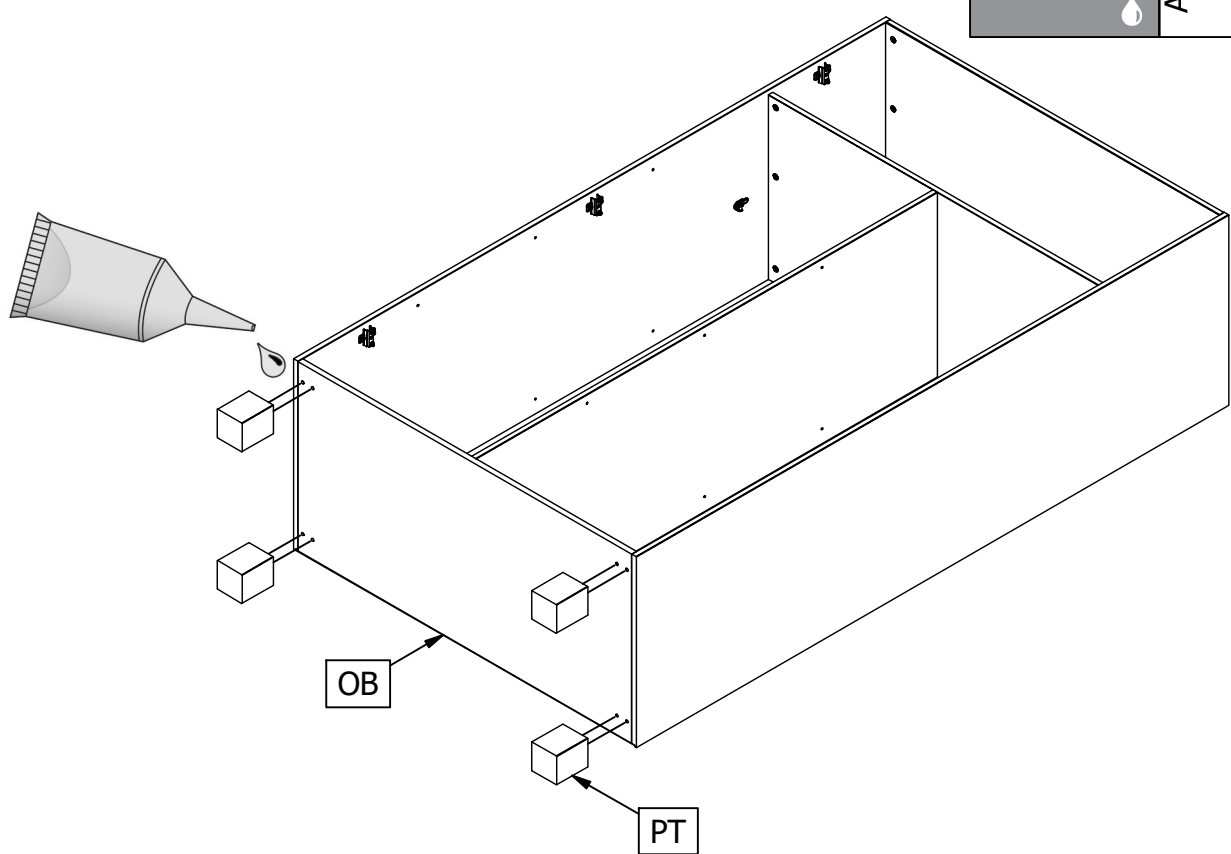
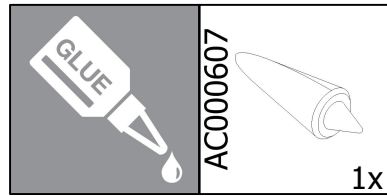

OB

PT

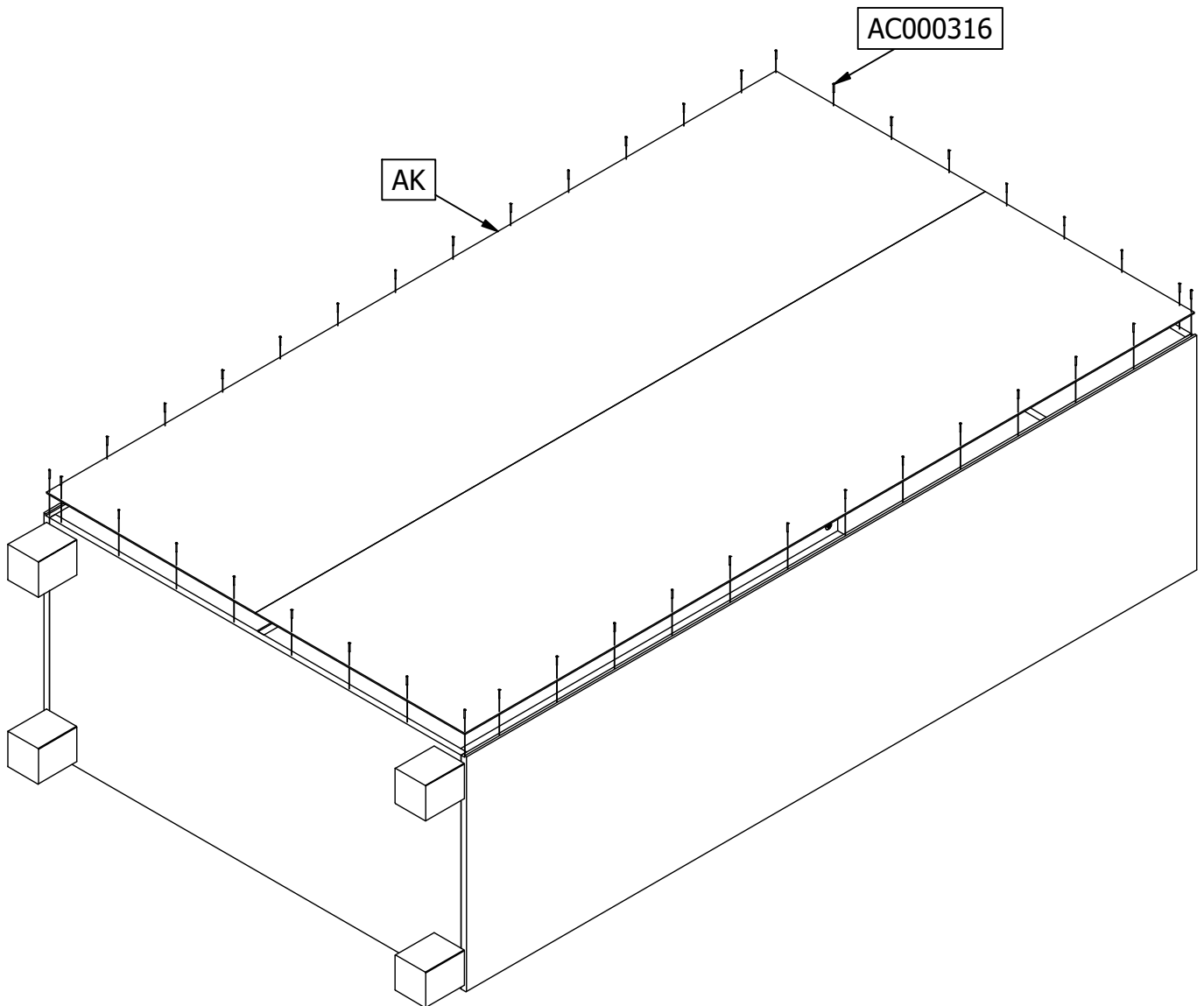
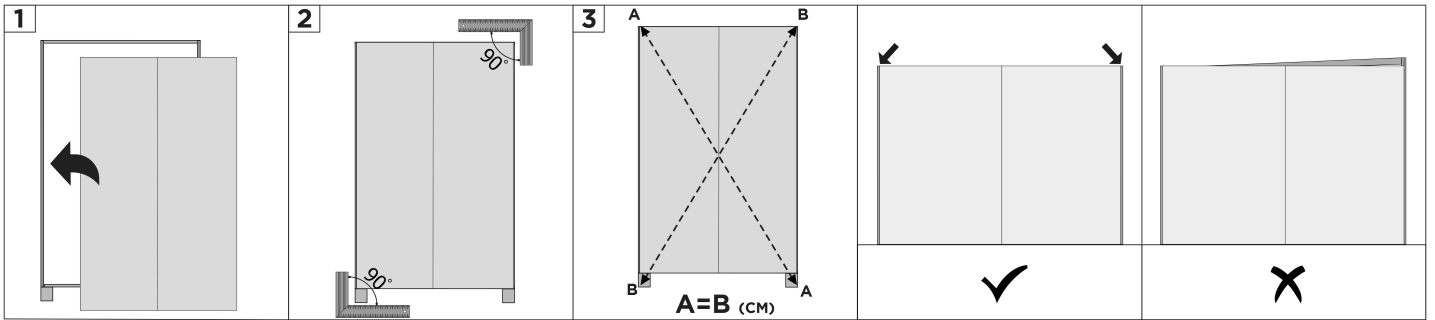
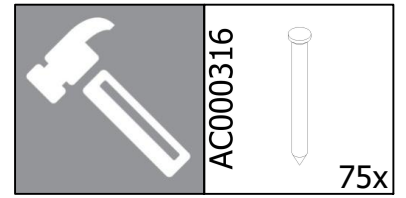

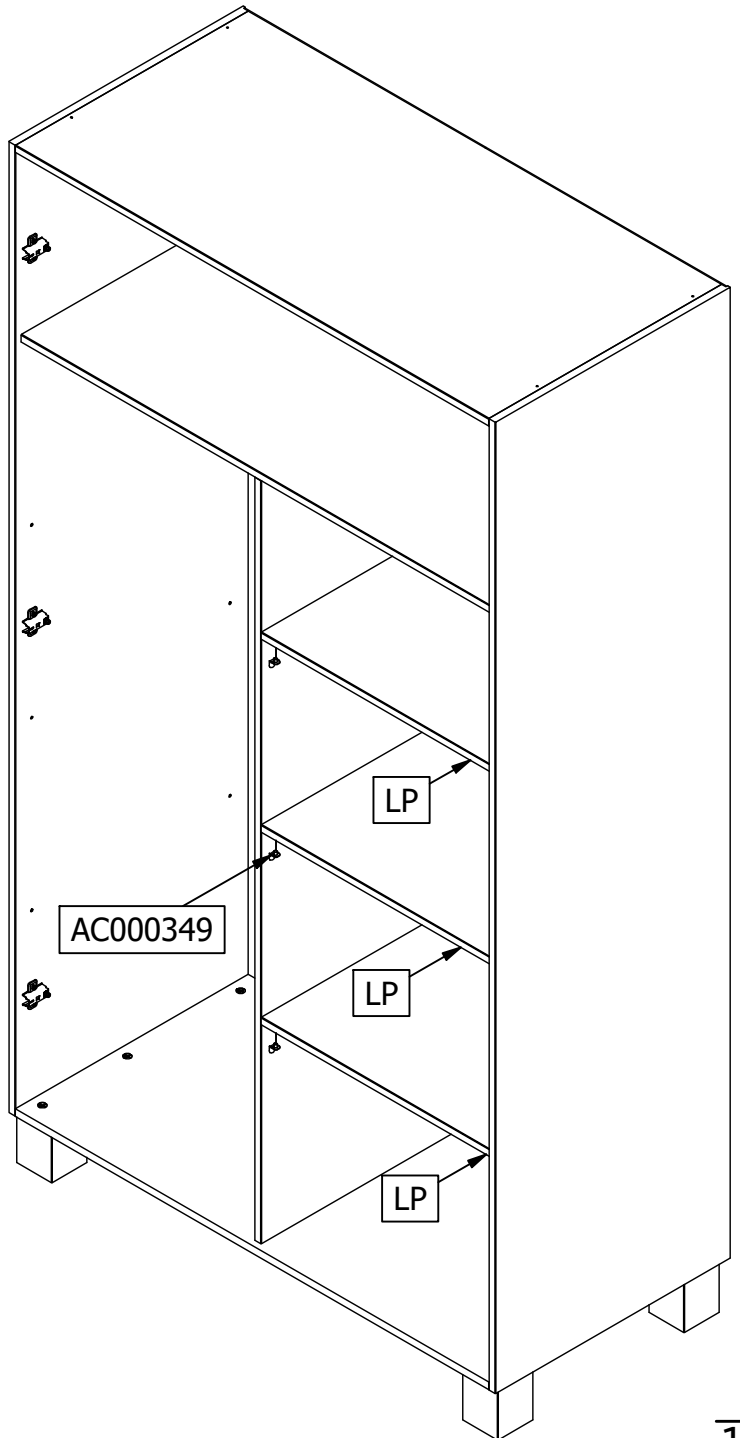
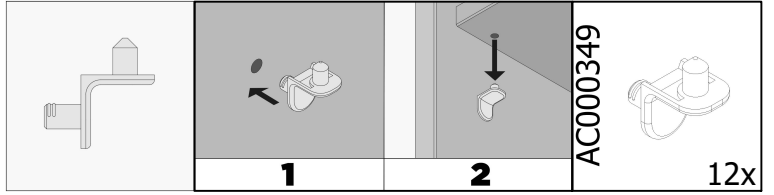
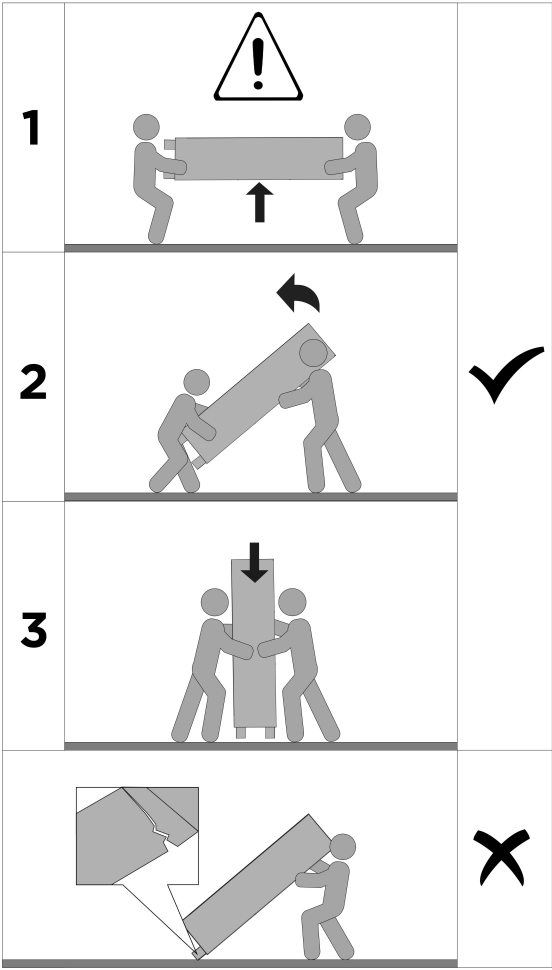

12

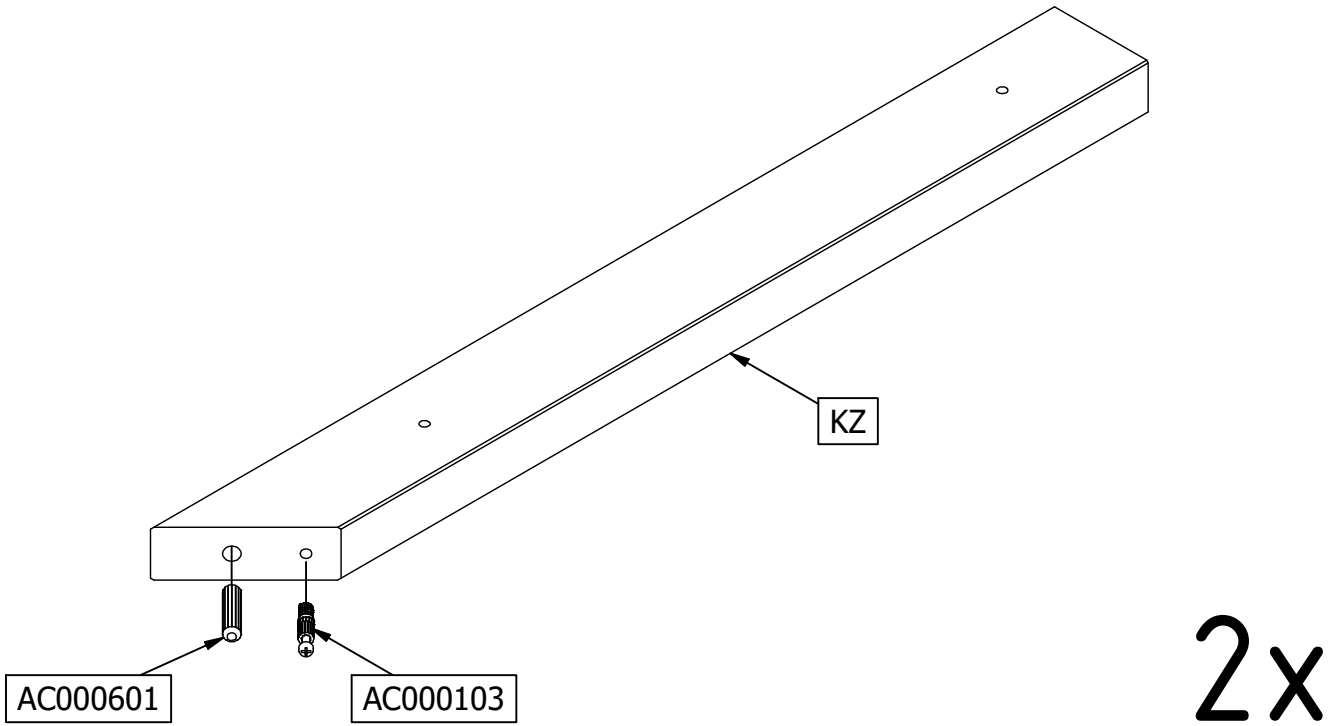
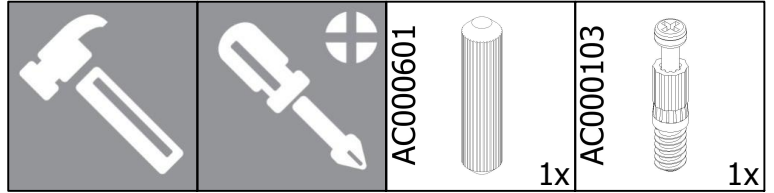
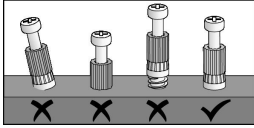

13

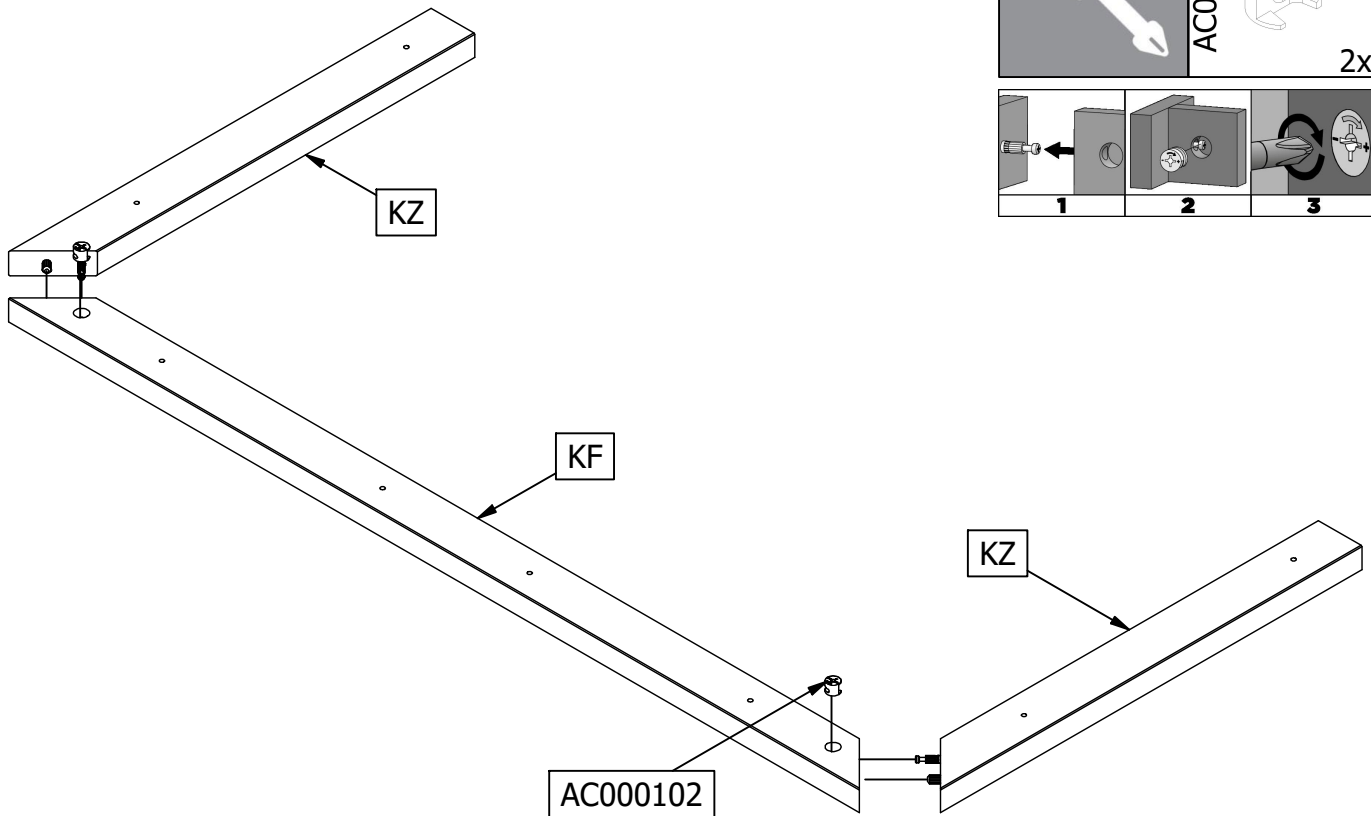
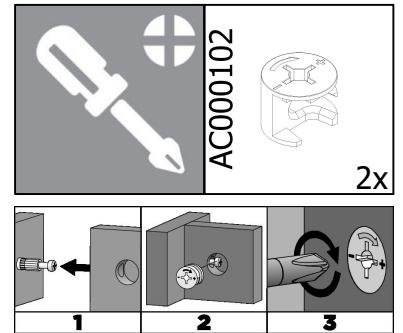

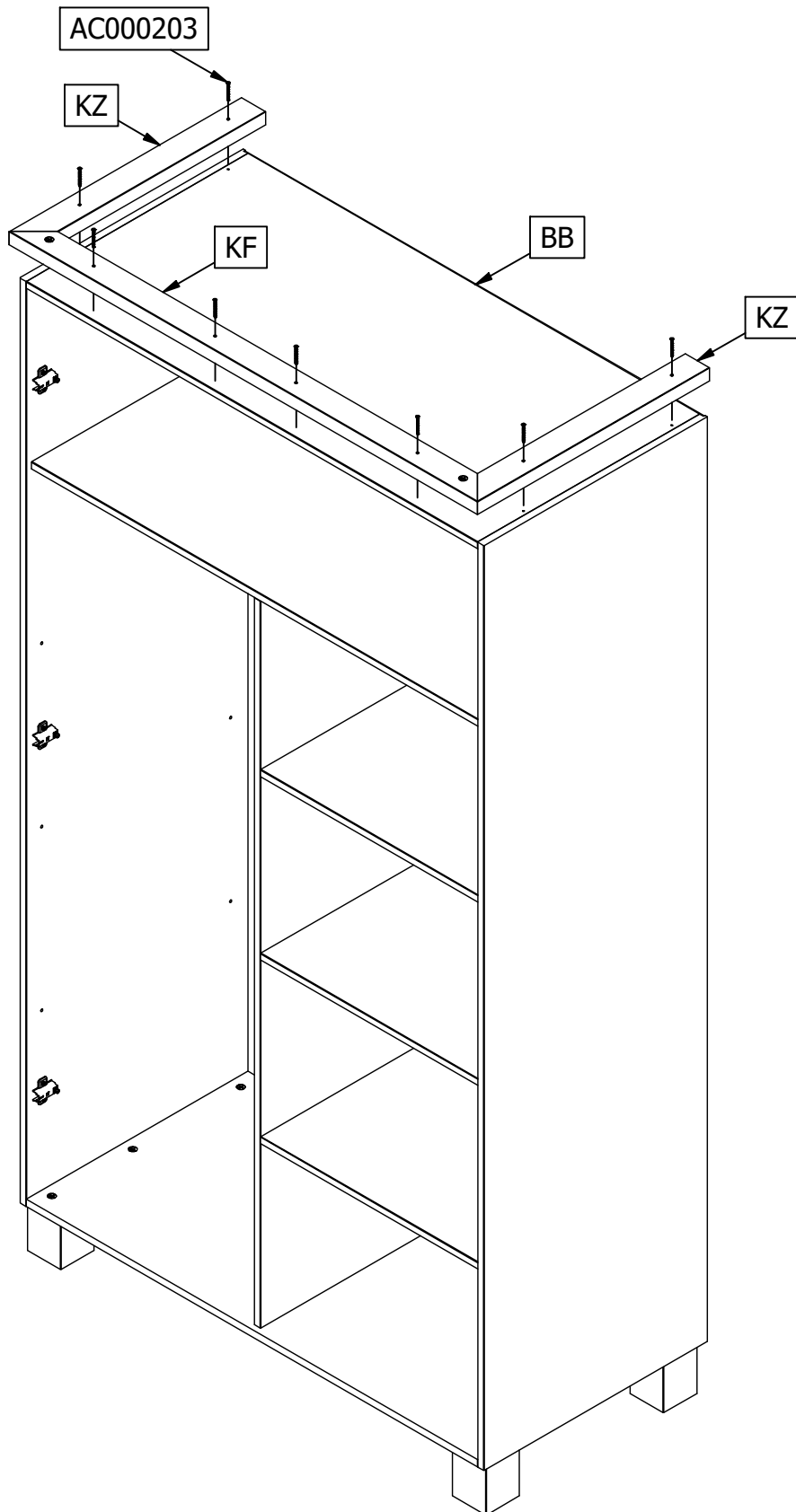
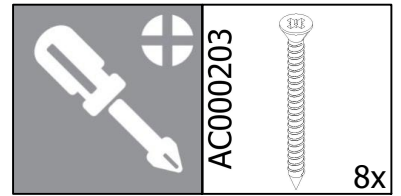

15

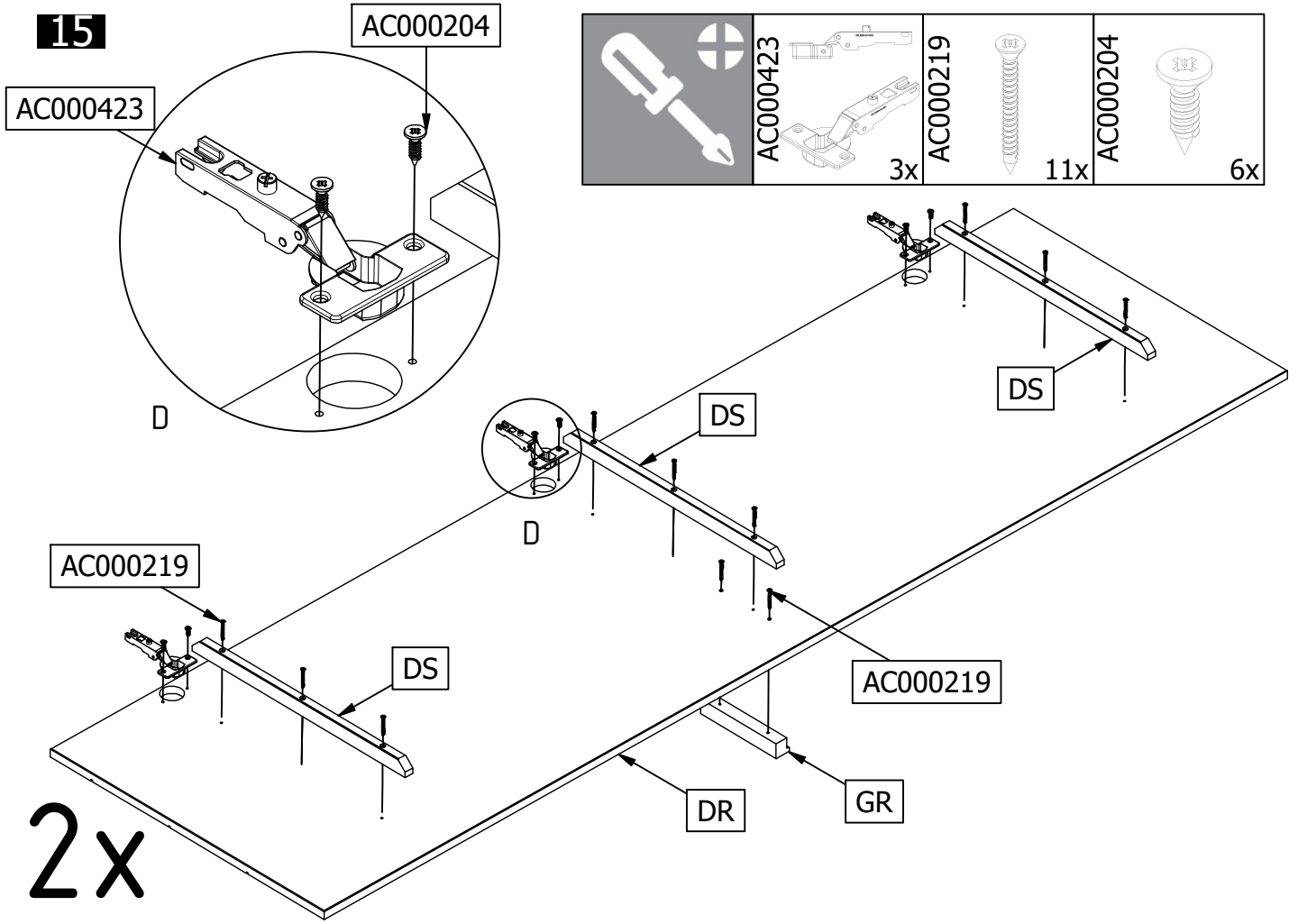

AC000423	3x	AC000219	11x
		AC000204	6x

16

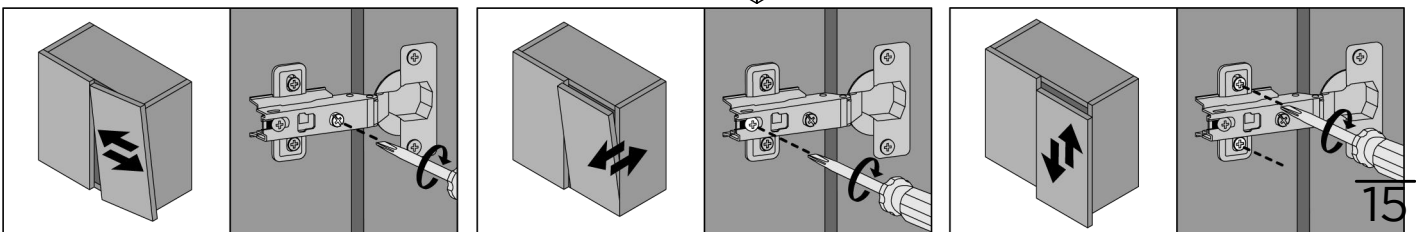
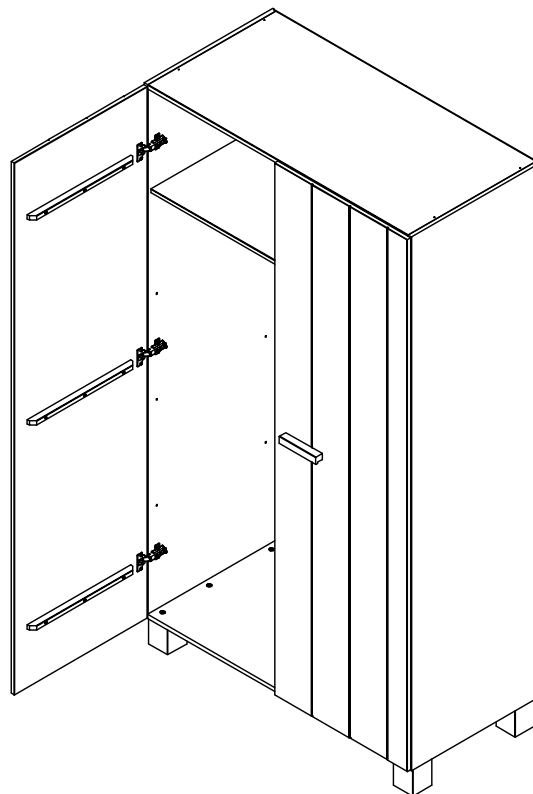

17

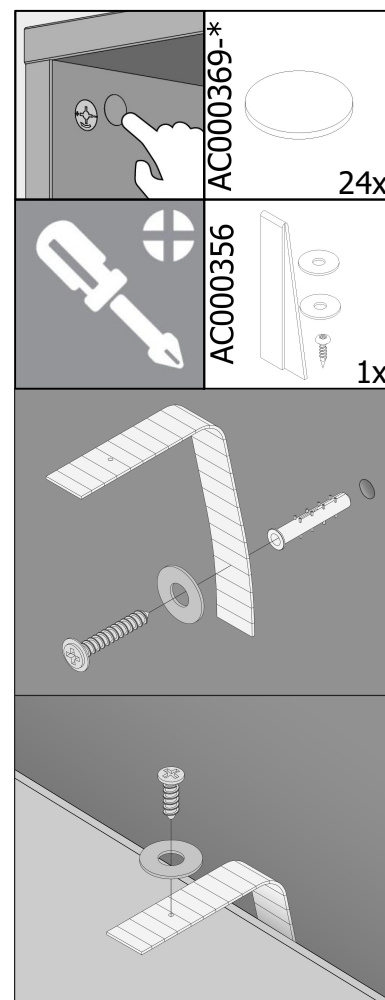
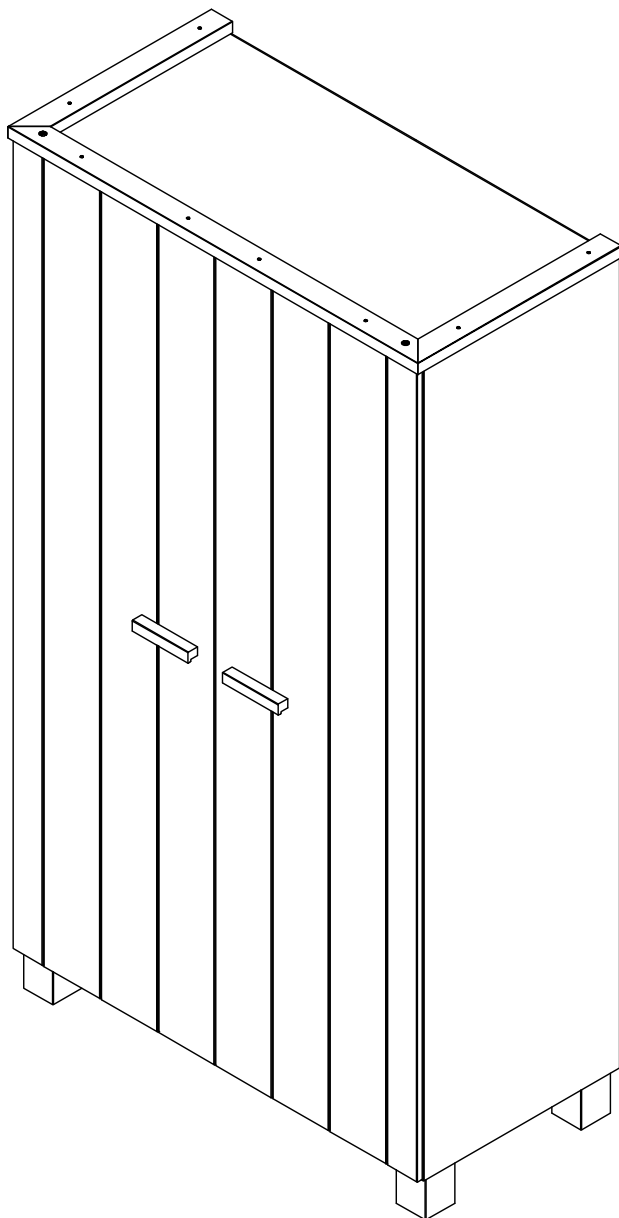
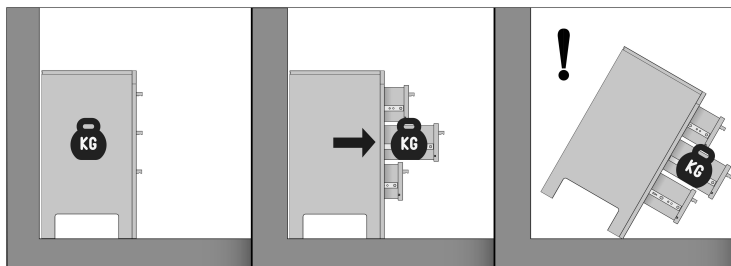

SOCIAL MEDIA

We zijn benieuwd naar het resultaat! Mocht je het met ons willen delen, gebruik #WOOOD op social media.
 We are curious about the result! Would you like to share it with us? Use #WOOOD on social media.
 Wir sind gespannt auf das Ergebnis! Möchten Sie es mit uns teilen? Benutzen Sie #WOOOD in Social Media.
 Nous sommes impatient de connaître le résultat. Souhaitez-vous le partager avec nous? Utilisez #WOOOD sur les médias sociaux.



facebook.com/wood.nl
 instagram.com/madebywood
 pinterest.com/madebywood