

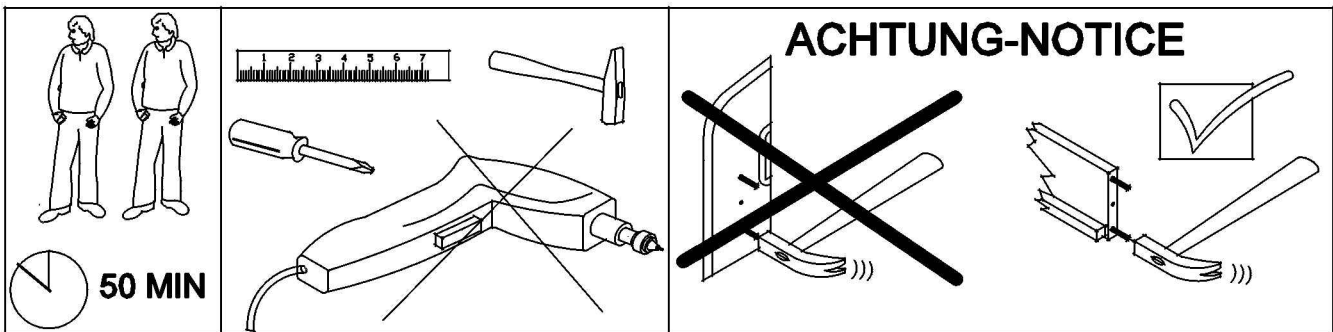

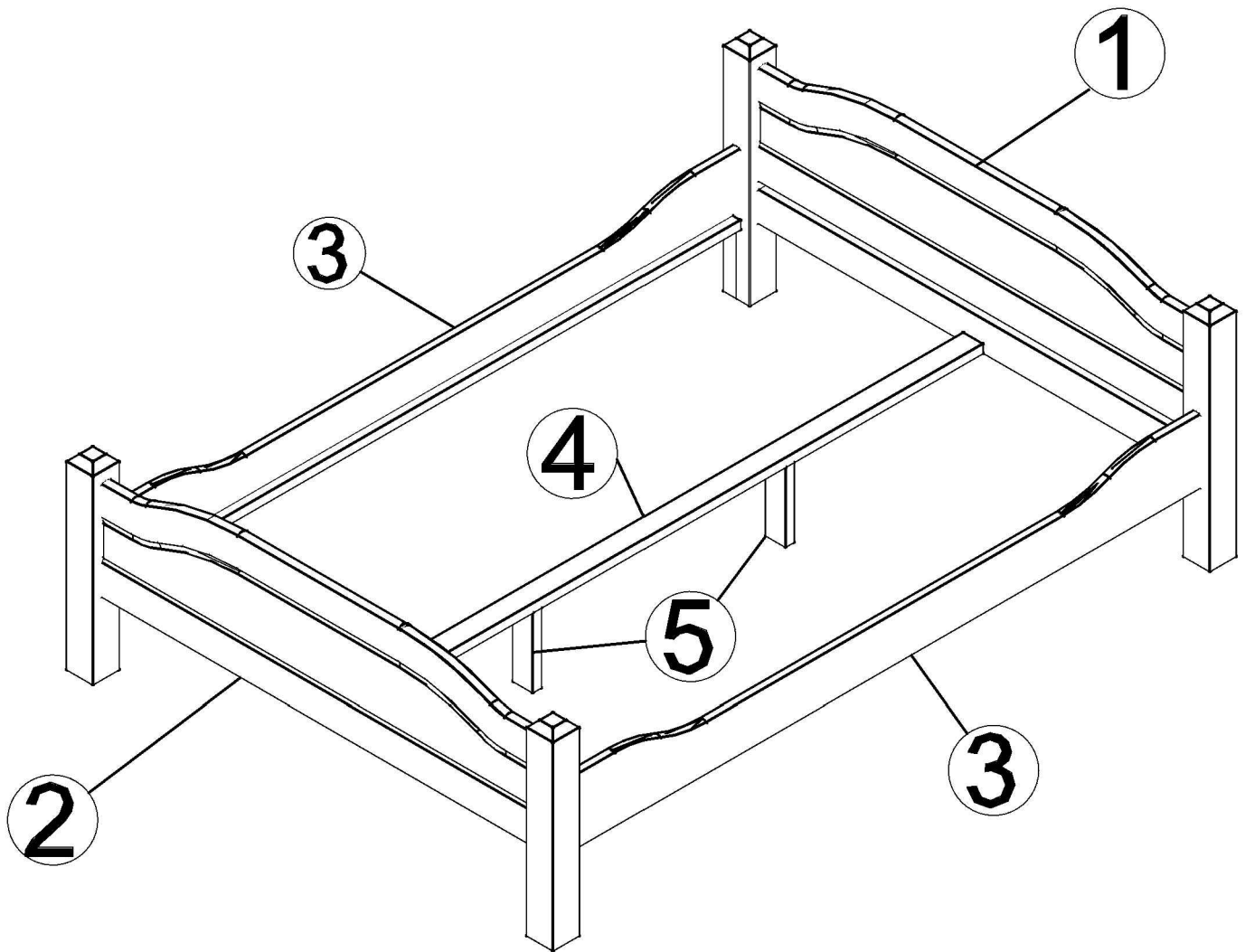









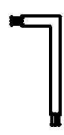

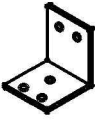
MONTAGEANLEITUNG (120-200)X200

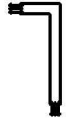

A	B	C	D	E	F	G
M6x120	Ø10x13	Ø10x40	4mm	Ø4x60	40X40X40	Ø3,5x16
						
x4	x4	x12	x1	x2	x2	x10

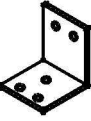
Teil nr.	Menge	Mass L X B X T(MM)
1	1	„120,,1310 X 705 X 78/25
		„140,,1510 X 705 X 78/25
		„180,,1810 X 705 X 78/25
		„200,,2010 X 705 X 78/25
2	1	„120,,1310 X 605 X 78/25
		„140,,1510 X 605 X 78/25
		„180,,1810 X 605 X 78/25
		„200,,2010 X 605 X 78/25
3	2	1960 X 200 X 20
4	1	2000 X 60 X 25
5	2	215 X 60 X 25

A	B	C	D	E	F	G
M6x120	Ø10x13	Ø10x40	4mm	Ø4x60	40X40X40	Ø3,5x16
						
x4	x4	x12	x1	x2	x2	x10

