

1**2**

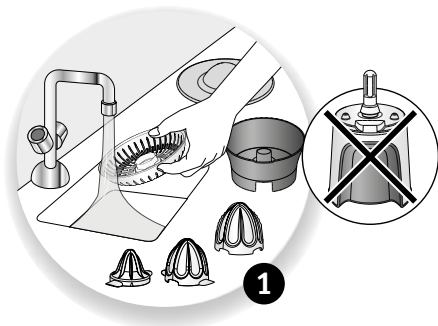

3

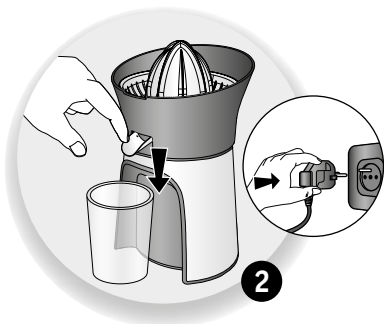
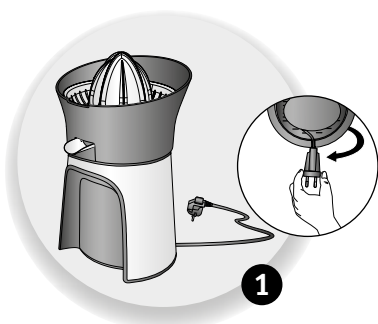
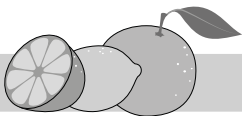
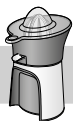
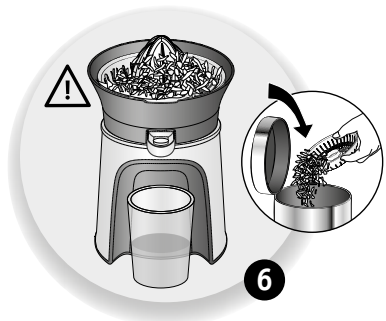
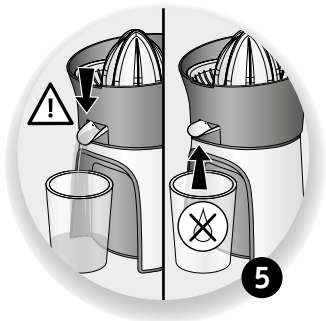
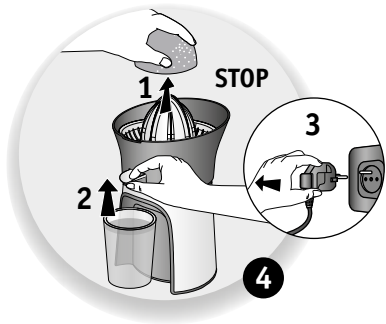
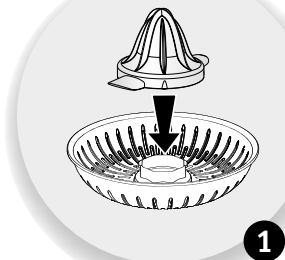

1

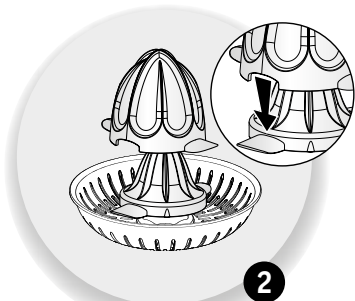

2

* 15s ON and then rest for 15s, MAX 10 min

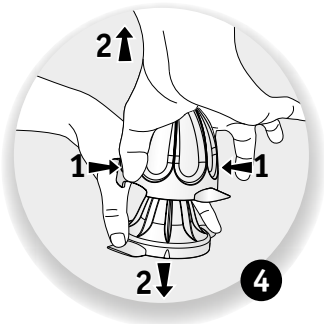
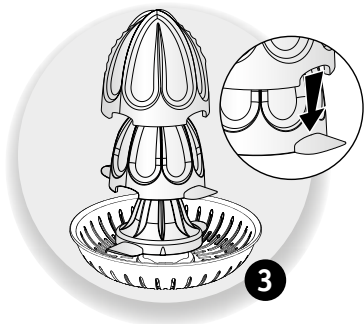

4

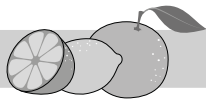

5



6

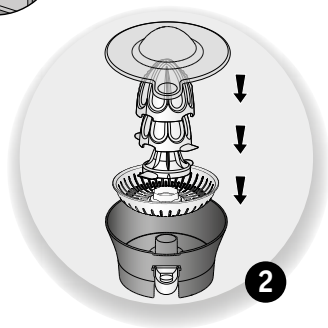
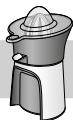

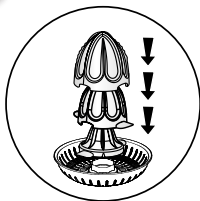
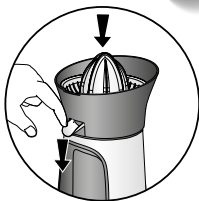
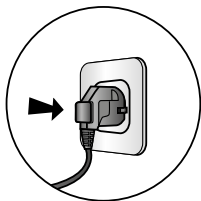
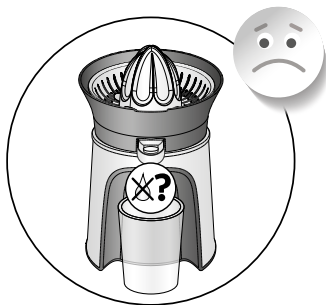

INTERNATIONAL GUARANTEE: COUNTRY LIST
SMALL HOUSEHOLD APPLIANCES

ARGENTINA	0800-122-2732	مصر EGYPT	16622	VIETNAM	1800-555521	МАКЕДОНИЈА MACEDONIA	(02) 20 50 319
ՀԱՅԱՍՏԱՆ ARMENIA	010 55-76-07	EESTI ESTONIA	668 1286	SLOVENIJA SLOVENIA	02 234 94 90	MALAYSIA	603 7802 3000
AUSTRALIA	1300307824	SUOMI FINLAND	09 8946 150	ΕΛΛΑΔΑ GREECE	2106371251	MEXICO	(55) 52839354
ÖSTERREICH AUSTRIA	01 890 3476	FRANCE Continentale = Guadeloupe, Martinique, Réunion, St-Martin	09 74 50 47 74	香港 HONG KONG	8130 8998	MOLDOVA	22 224035
البحرين BAHRAIN	17716666	DEUTSCHLAND GERMANY	0212 387 400	MAGYARORSZÁG HUNGARY	06 1 801 8434	NEDERLAND The Netherlands	0318 58 24 24
БЕЛАРУСЬ BELARUS	017 2239290	سلطنة عمان OMAN	24703471	INDONESIA	+62 21 5793 7007	NEW ZEALAND	0800 700 711
BELGIQUE BELGIE BELGIUM	070 23 31 59	POLSKA POLAND	801 300 420 koszt jak za połączenie lokalne	ITALIA ITALY	1 99 207 354	NORGE NORWAY	22 96 39 30
BOSNA I HERCEGOVINA	Info-linija za potrošače 033 551 220	PORTUGAL	808 284 735	日本 JAPAN	0570-077772	ESPAÑA SPAIN	933 06 37 65
BRASIL BRAZIL	11 2915-4400	قطر QATAR	44485555	الأردن JORDAN	5665505	SVERIGE SWEDEN	08 629 25 00
БЪЛГАРИЯ BULGARIA	0700 10 330	REPUBLIC OF IRELAND	01 677 4003	ҚАЗАҚСТАН KAZAKHSTAN	727 378 39 39	SUISSE SCHWEIZ SWITZERLAND	044 837 18 40
CANADA	1-800-418-3325	ROMANIA	0 21 316 87 84	한국어 KOREA	080-733-7878	ประเทศไทย THAILAND	02 765 6565
CHILE	02 2 884 46 06	РОССИЯ RUSSIA	495 213 32 30	الكويت KUWAIT	1807777 Ext :2104	TÜRKİYE TURKEY	444 40 50
COLOMBIA	018000520022	المملكة العربية السعودية SAUDI ARABIA	920023701	LATVIJA LATVIA	6 616 3403	الإمارات العربية المتحدة UAE	8002272
HRVATSKA CROATIA	01 30 15 294	SRBIJA SERBIA	060 0 732 000	لبنان LEBANON	4414727	Україна UKRAINE	044 300 13 04
ČESKÁ REPUBLIKA CZECH REPUBLIC	731 010 111	SINGAPORE	6550 8900	LIETUVA LITHUANIA	5 214 0057	UNITED KINGDOM	0345 602 1454
DANMARK DENMARK	43 350 350	SLOVENSKO SLOVAKIA	232 199 930	LUXEMBOURG	0032 70 23 31 59	U.S.A.	800-395-8325
24/10/2018							

Date of purchase / Date d'achat / Fecha de compra / Kobtsdato / Ostopäivä / Kjøpsdato / Inköpsdatum / Ostukuupäev / Pirkuma datums / [Sjijigimo data / Data zakupu / Datum izročitve blaga / Datum kupovine / Vásárlás dátuma / Data achiziției / Дата на закупуване / Дата продажы / Чудуириги ор. / Дата продажы / Сатылган күни / 購入日 / خریداری / Datum na kupovanje :

Product reference / Référence produit / Referencia del producto / Referencenummer / Tuotenumero / Artikkelnummer / Produktreferens / Toote viitenumber / Produkta atsauce numurs / Gaminio numeris / Referenca produktu / Oznaka proizvoda / Tip aparata / Készülék típusa / Cod produs / Модел / Модель / Упатк / Модела / Yarıcı / 製品リファレンス番号 / ระบุผลิตภัณฑ์ / 제품명 / Податоци за производот :

Retailer name and address / Nom et adresse du revendeur / Nombre y dirección del minorista / Forhandler navn & adresse / Jälleenmyyjän nimi ja osoite / Forhandler navn og adresse / Återförsäljarens namn och adress / Müüja kauplus ja address / Veikala nosaukums un adrese / Parduotuvės pavadinimas ir adresas / Nazwa i adres sprzedawcy / Naziv i adresa prodajnog mjesta / Naziv in naslov trgovine / Forgalmazó neve és címe / Numele și adresa vânzătorului / Търговски обект / Назва та адреса продавця / Чудуириги продагчигул үндүлүмүдү и хуучуге. / Название и адрес продавца / Сатушының атауы мен мекен-жайы / 販売店名、住所 / ชื่อและที่อยู่ที่ของห้างร้านที่ซื้อ / 소매점 이름과 주소 / Име и адреса на продавач :

Distributor stamp / Cachet / Sello del distribuidor / Forhandler stempel / Jälleenmyyjän leima / Forhandler stempel / Återförsäljarens stämpel / Tempel / Zīmogs / Antspaudas / Pieczęć sprzedawcy / Pečet distributera / Pečet trgovine / Forgalmazó pecsétje / Štampila vânzătorului / Печат на търговския обект / Печатка продавця / 售印. / Печатъ продавця / Сатушының мөрү / 販売店印 / ตราประทับของห้างร้านที่ซื้อ / 소매점 직인 / Печат на дистрибутор :