

NOTICE DE MONTAGE

INSTRUCCIONES DE MONTAJE / ASSEMBLY INSTRUCTIONS

ME
marckeric

MARCKERIC S.L.
C/ENLACE VEROLA S/N
PC-46430/SOLLANA/VALENCIA/SPAIN

LIBRERIA UTAH 2P2C5H
BOOK-CASE UTAH 2D2DR5H
LIBRAIRIE UTAH 2P2T5N

14574

EAN CODE:
8435178383129

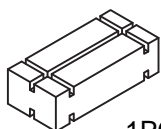

1PC / 2CTNS

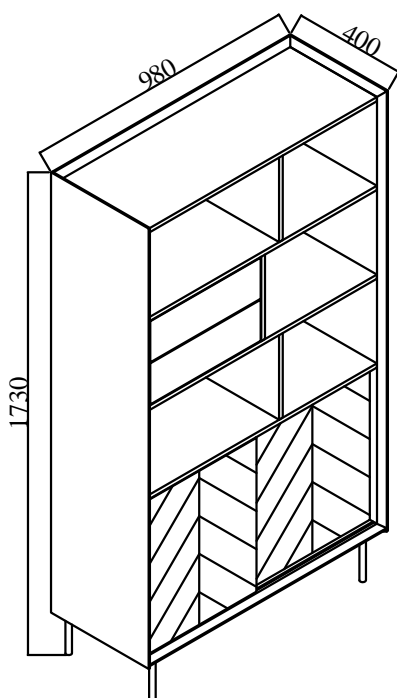

À MONTER SOI-MÊME

Tamaño de la cajas Dimensions colis Carton dimensions	Peso bruto poids brut Gross weight	Peso neto Poids net Net weight
1650x515x125mm	34.3kg	31.55kg
1020x455x180mm	30.9kg	29.15kg

AVANT DE COMMENCER, SE
REPORTER AUX CONSEILS
DE MONTAGE EN ANNEXE

**BEFORE STARTING, REFER
TO THE ASSEMBLING ADVICE
IN ANNEX**

VOR DER MONTAGE,
BEILIEGENDE ANWEISUNGEN
BEFOLGEN.

PRIMA DI COMINCIARE
LEGGETE LE ISTRUZIONI DI
MONTAGGIO

ANTES DE COMENZAR, ADIAR
SE AOS CONSELHOS DE
MONTAGEM EM ANEXO

**ANTES DE EMPEZAR
CONSULTE LOS CONSEJOS
PARA EL MONTAJE**

PRIJE POČETKA MONTAŽE
MOLIMO PAŽLJIVO
PROČITAJTE UPUTE ZA
MONTAŽU
**BASLAMADAN ÖNCE,
EKTEKI MONTAJ TALIMATLARINI
İNCELEYİNİZ**

IMPORTANT: À CONSERVER POUR RÉFÉRENCE ULTÉRIEURE-LIRE ATTENTIVEMENT

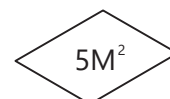
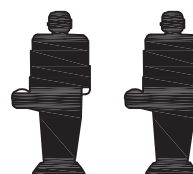
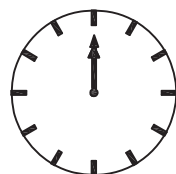
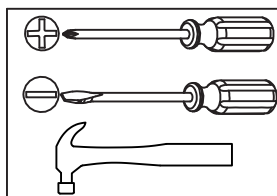

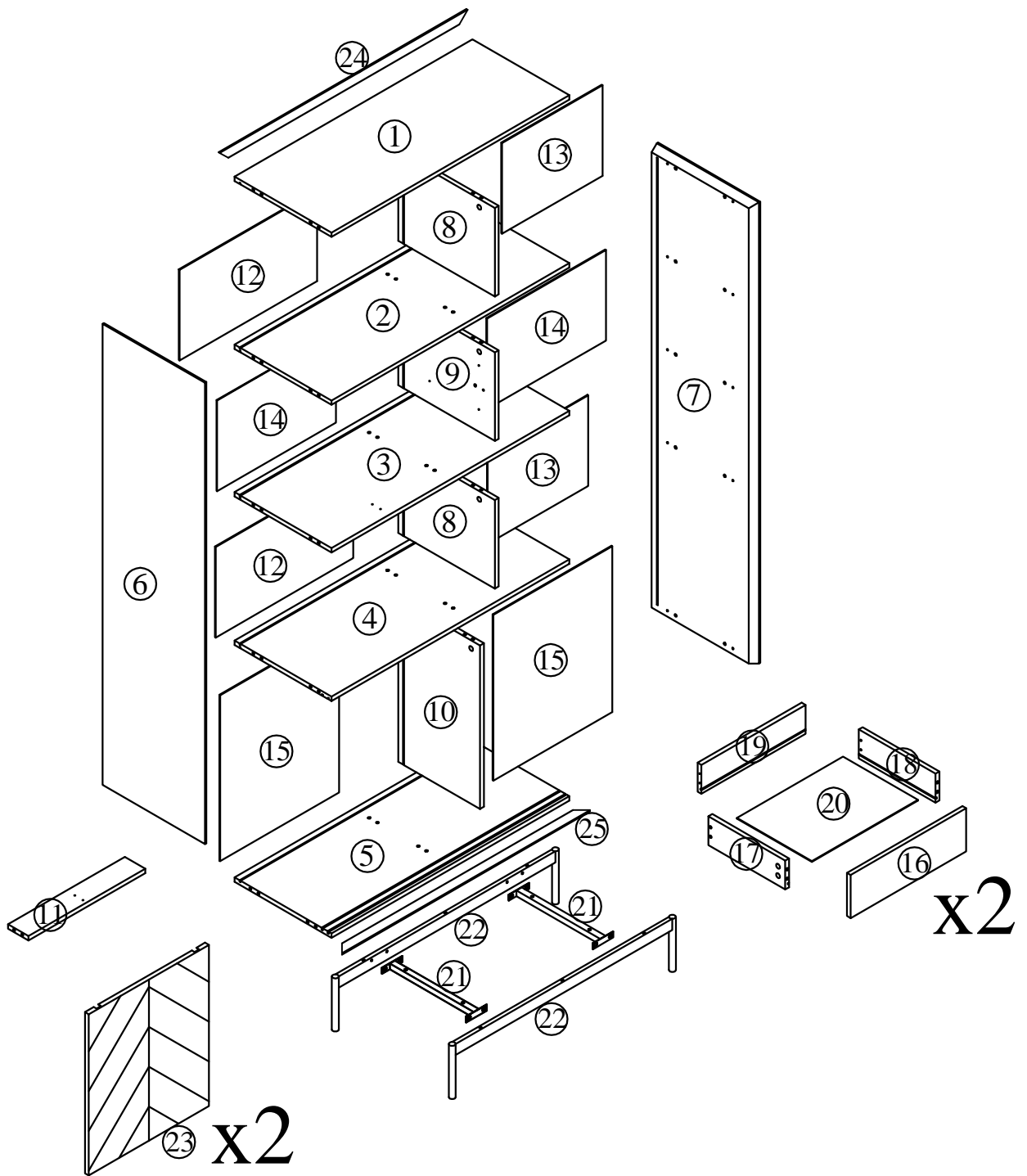

CAJA/COLIS 1/2		CAJA/COLIS 2/2	
1 x PIECES 06	2 x PIECES 15	1 x PIECES 01	1 x PIECES 10
1 x PIECES 07	2 x PIECES 19	1 x PIECES 02	2 x PIECES 16
1 x PIECES 11	2 x PIECES 21	1 x PIECES 03	2 x PIECES 17
2 x PIECES 12	2 x PIECES 23	1 x PIECES 04	2 x PIECES 18
2 x PIECES 13	1 x PIECES 24	1 x PIECES 05	2 x PIECES 20
2 x PIECES 14	1 x PIECES 25	2 x PIECES 08	2 x PIECES 22
		1 x PIECES 09	

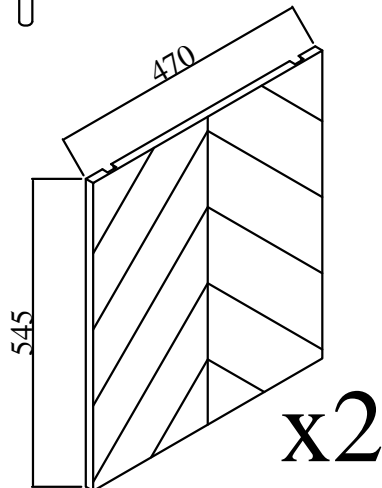
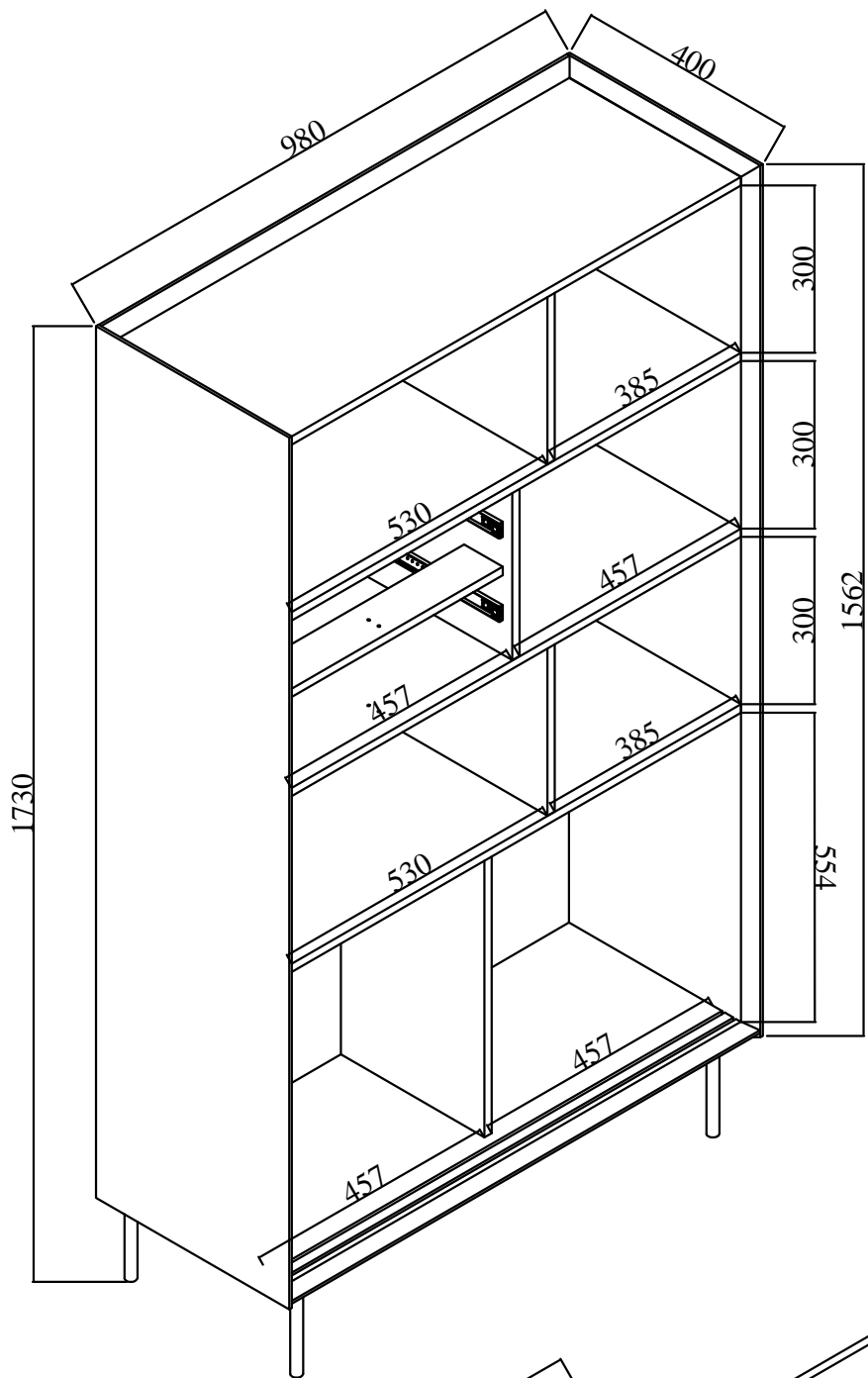



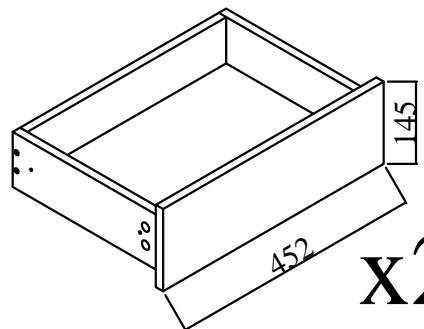



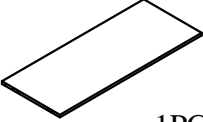
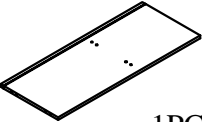
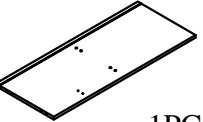
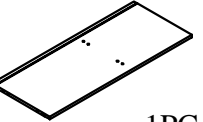
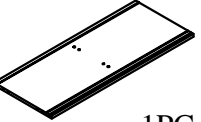

x2



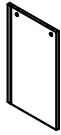
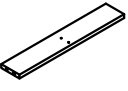
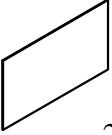
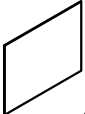
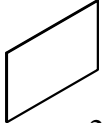
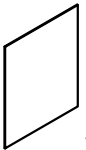
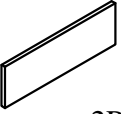

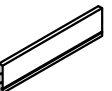
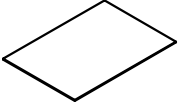
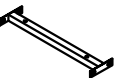

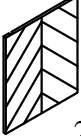
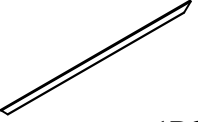
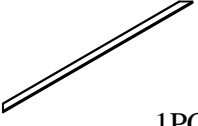



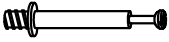

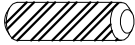

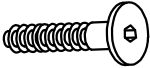

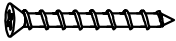
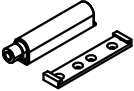

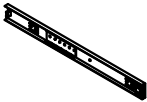

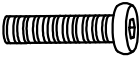

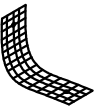

x2

LISTADO DE PIEZAS COMPOSANTS PART LIST

1	2	3	4	5	6
 1PC	 1PC	 1PC	 1PC	 1PC	 1PC
930x379x15mm	930x379x15mm	930x379x15mm	930x379x15mm	930x379x15mm	1562x400x25mm
7	8	9	10	11	12
 1PC	 2PCS	 1PC	 1PC	 1PC	 2PCS
1562x400x25mm	378x300x15mm	378x300x15mm	554x320x15mm	457x80x15mm	538x307x3mm
13	14	15	16	17	18
 2PCS	 2PCS	 2PCS	 2PCS	 2PCS	 2PCS
393x307x3mm	465x307x3mm	562x465x3mm	452x145x15mm	300x98x15mm	300x98x15mm
19	20	21	22	23	24
 2PCS	 2PCS	 2PCS	 2PCS	 2PCS	 1PC
407x98x15mm	415x293x3mm	330x80x20mm	880x180x19mm	545x470x15mm	968x25x20mm
25					
 1PC					
968x34x24mm					

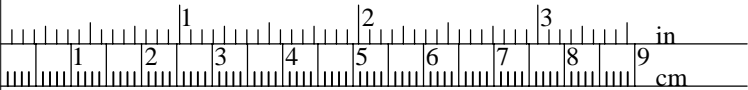
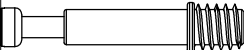
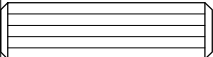
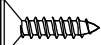

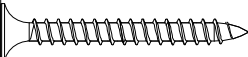
HERRAJES / QUINCALLERIE / HARDWARE

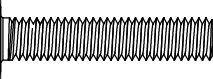
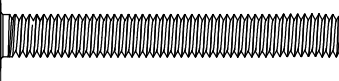
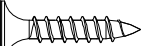
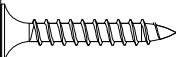
A	B	C	D	E	F
 38PCS	 38PCS	 38PCS	 72PCS	 8PCS	 1PC
G	H	I	J	K	L
 8PCS	 2PCS	 2PCS	 4PCS	 4PCS	 8PCS
M	N	O	P	Q	R
 4PCS	 6PCS	 14PCS	 4PCS	 32PCS	 2PCS
S	T	U	V		
 4PCS	 4PCS	 4PCS	 4PCS		

		
A x 38		6 x 35
C x 38		8 x 30
D x 72		3.5 x 14
E x 8		7 x 40
G x 8		4 x 35
L x 8		M6 x 12
M x 4		M6 x 30
N x 6		M6 x 48
S x 4		4 x 20
T x 4		4 x 25

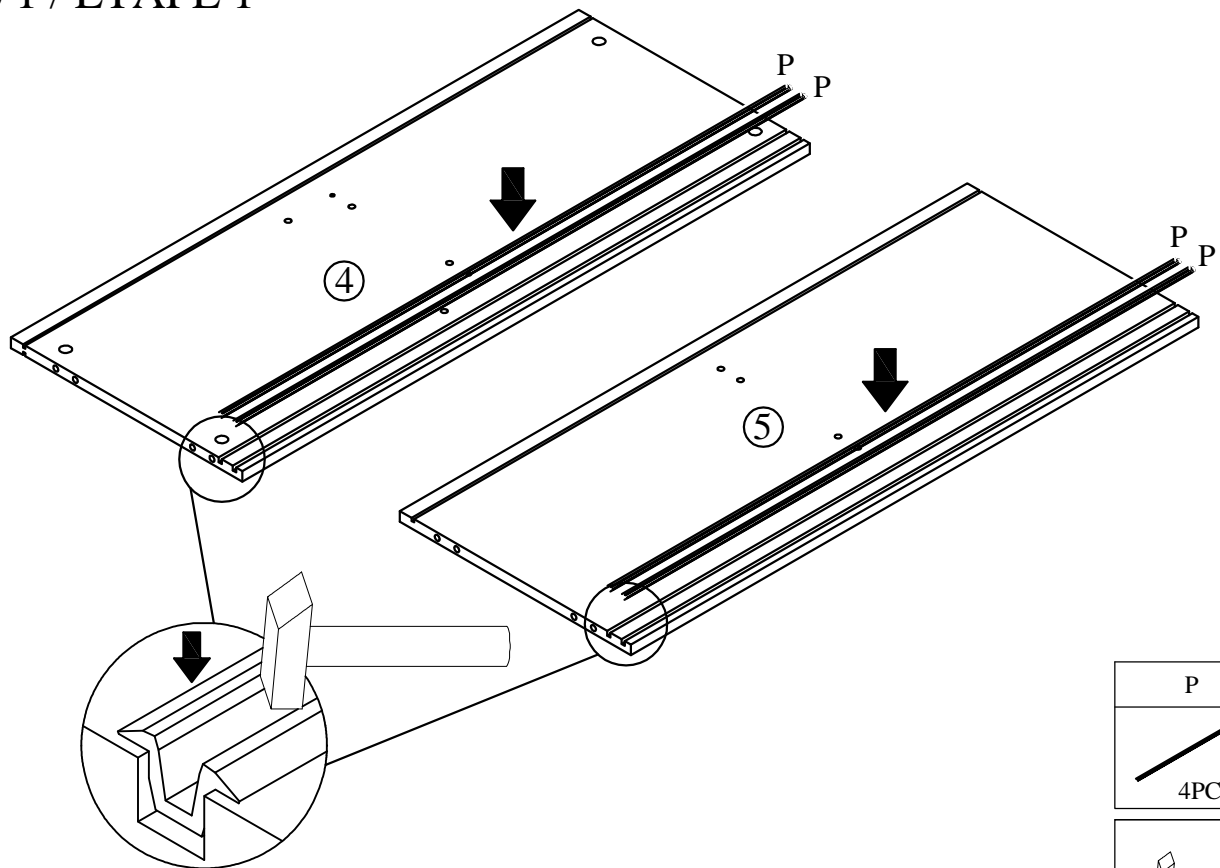

Step 1 / ETAPE 1



P
 4PCS

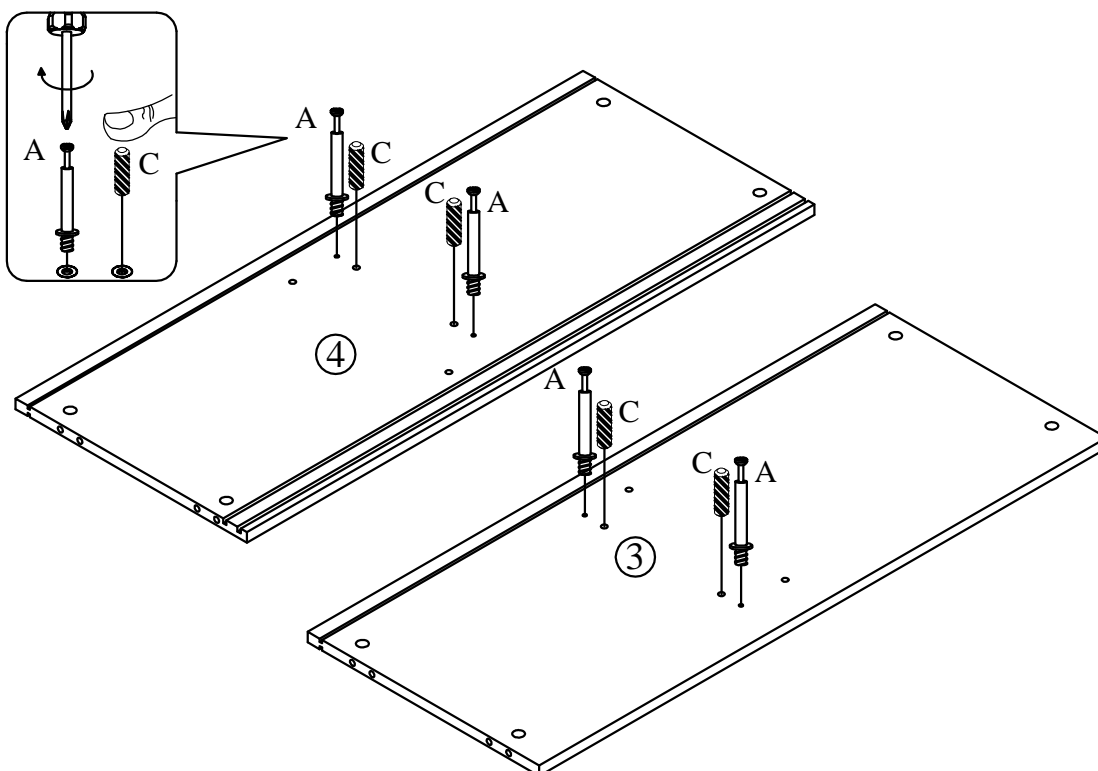

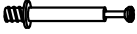
Step 2 / ETAPE 2



A
 4PCS
C
 4PCS

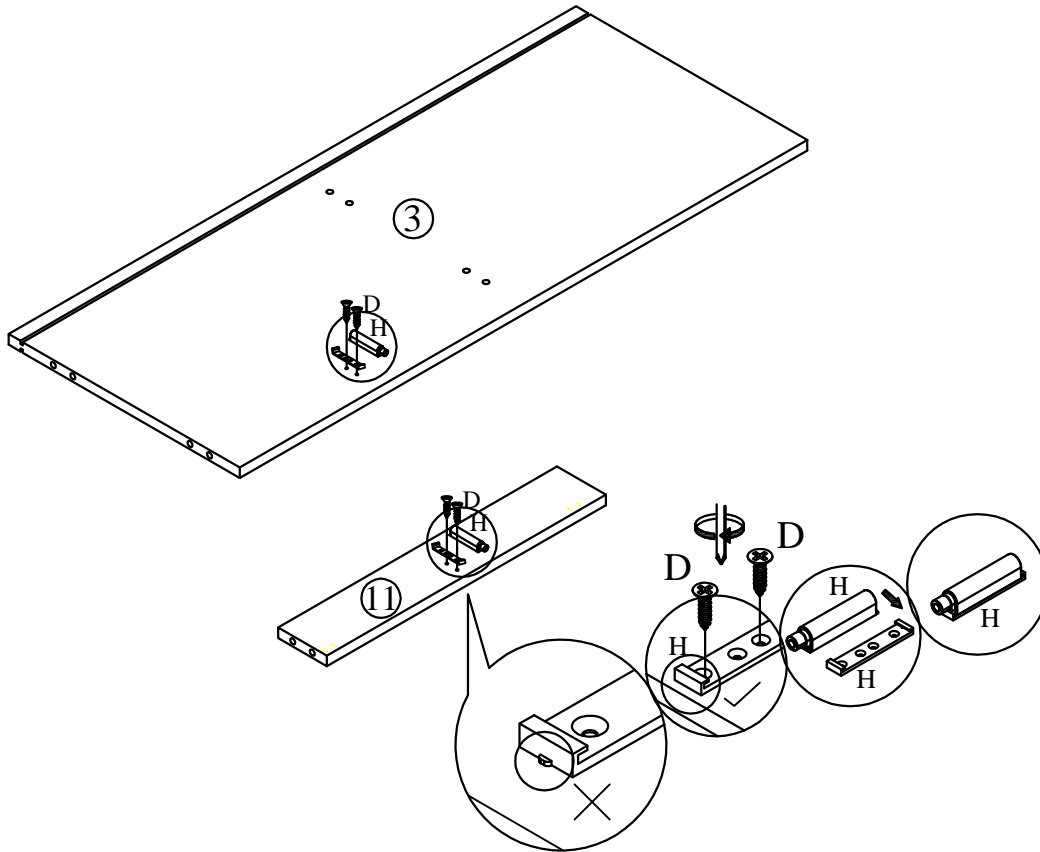

Step 3 / ETAPE 3

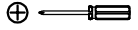

D

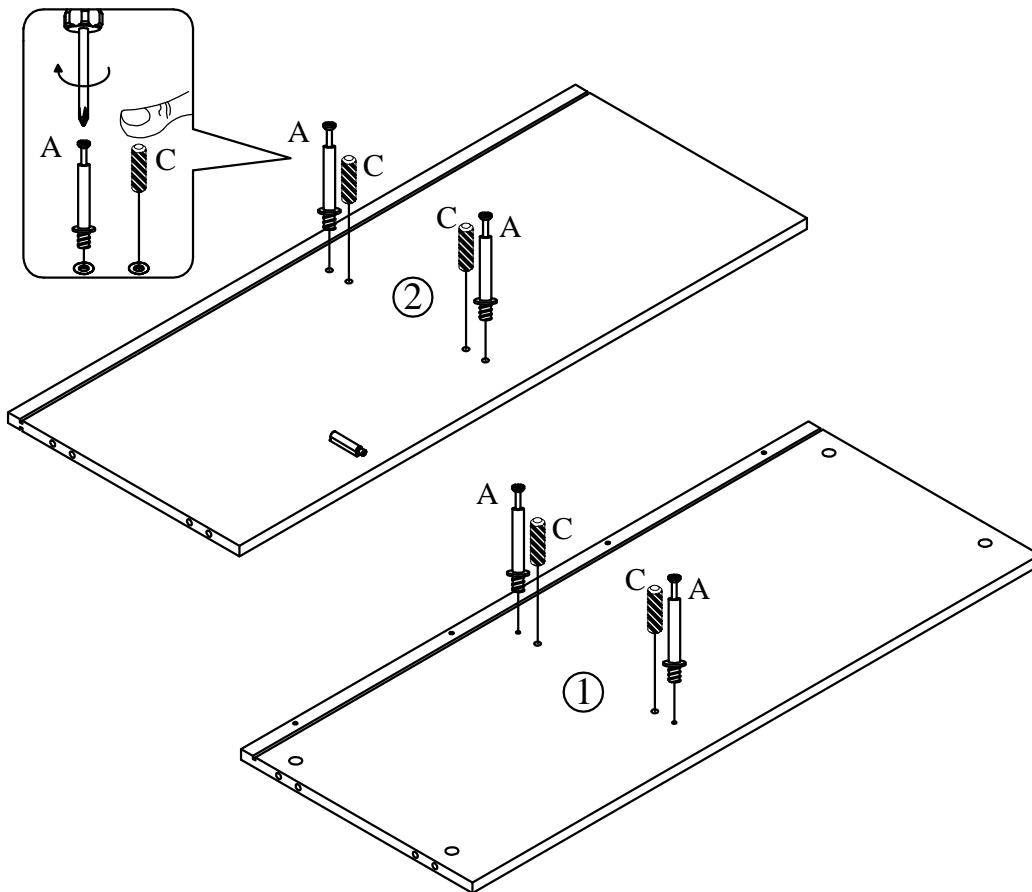
4PCS
H

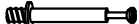
2PCS

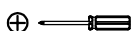

Step 4/ ETAPE 4

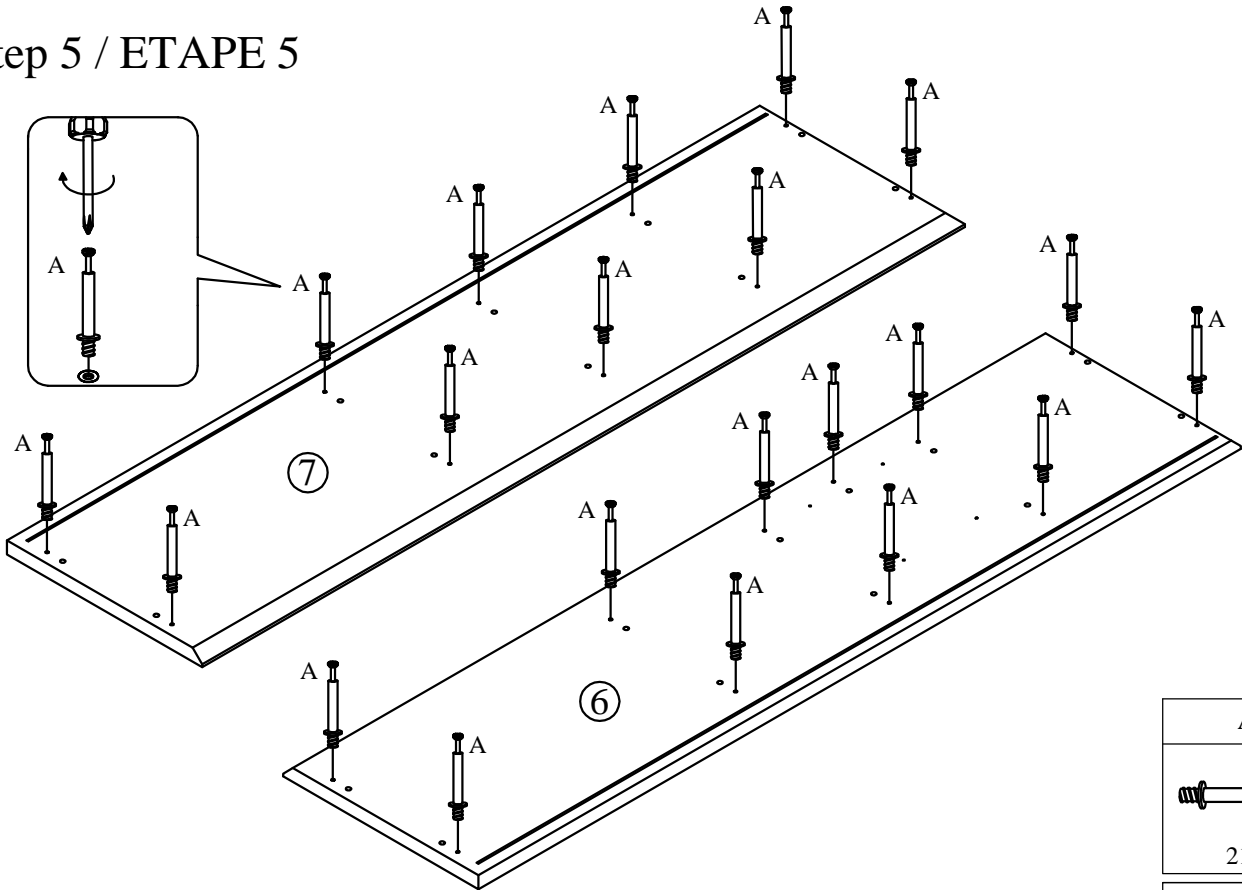

A

4PCS
C

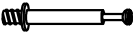
4PCS

Step 5 / ETAPE 5



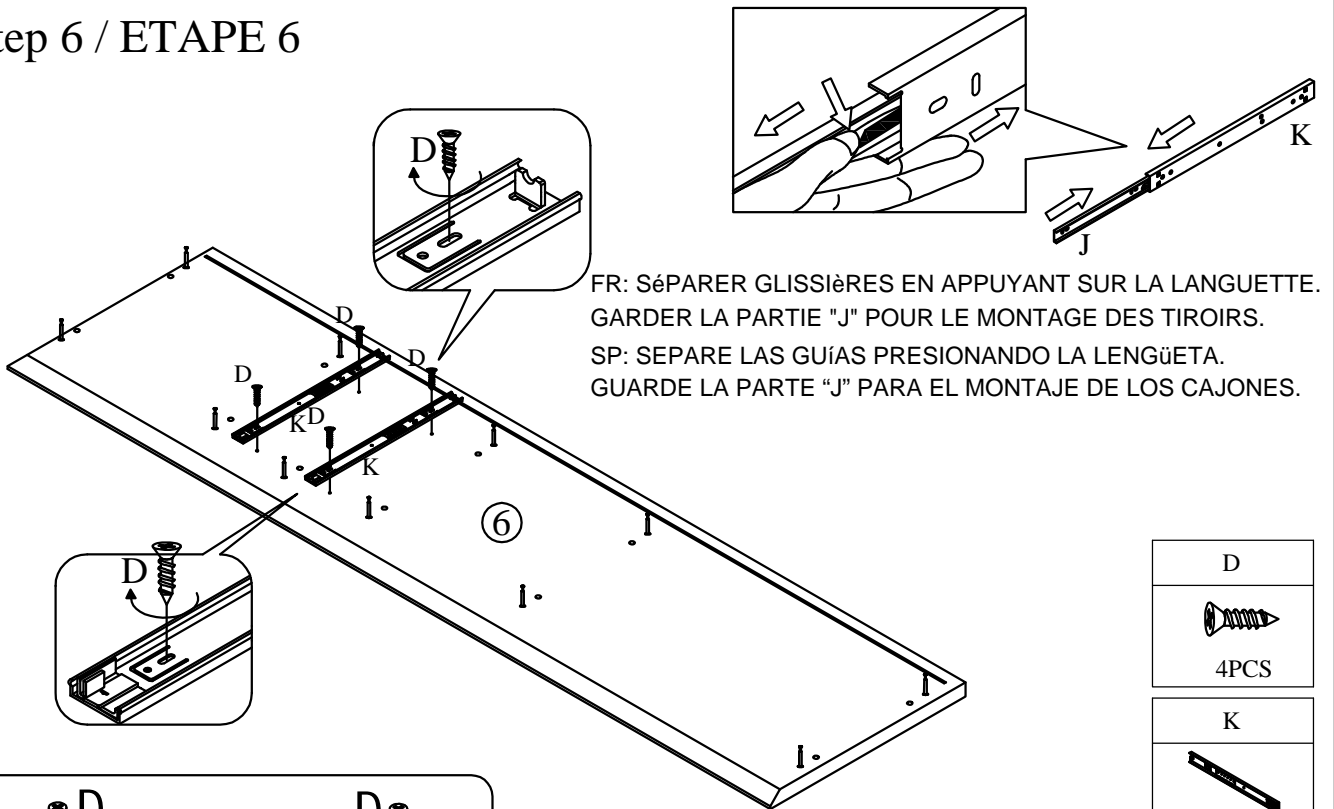

A

21PCS

Step 6 / ETAPE 6

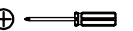

FR: SÉPARER GLISSIÈRES EN APPUYANT SUR LA LANGUETTE.
GARDER LA PARTIE "J" POUR LE MONTAGE DES TIROIRS.
SP: SEPARAR LAS GUÍAS PRESIONANDO LA LENGÜETA.
GUARDE LA PARTE "J" PARA EL MONTAJE DE LOS CAJONES.

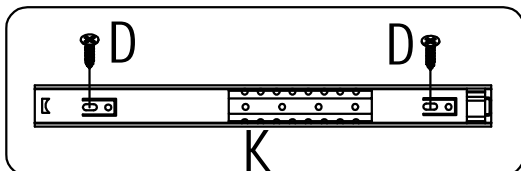
D

4PCS
K

2PCS

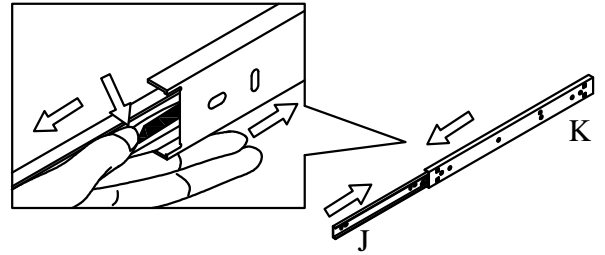
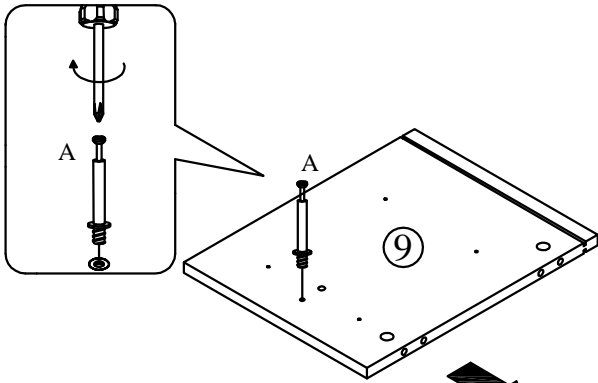

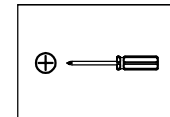
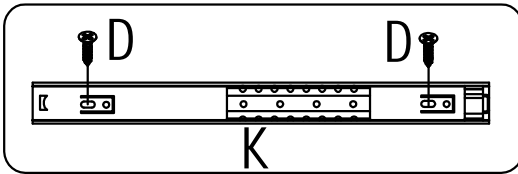
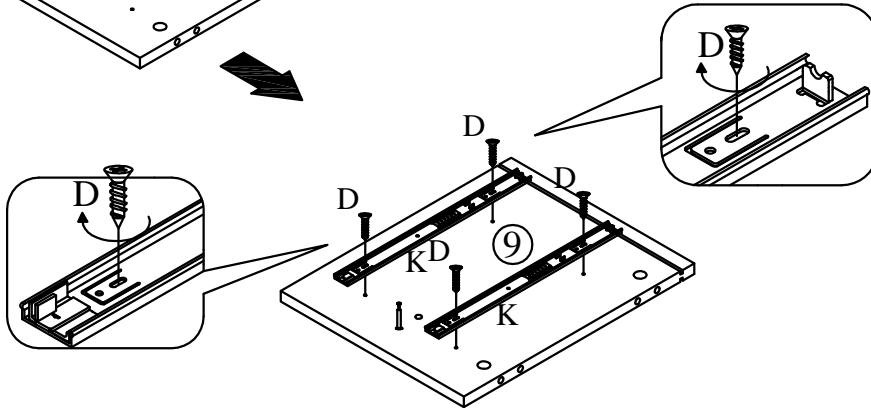

Step 7 / ETAPE 7





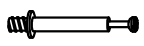

FR: SÉPARER GLISSIÈRES EN APPUYANT SUR LA LANGUETTE.
 GARDER LA PARTIE "J" POUR LE MONTAGE DES TIROIRS.
 SP: SEPARA LAS GUÍAS PRESIONANDO LA LENGÜETA.
 GUARDE LA PARTE "J" PARA EL MONTAJE DE LOS CAJONES.

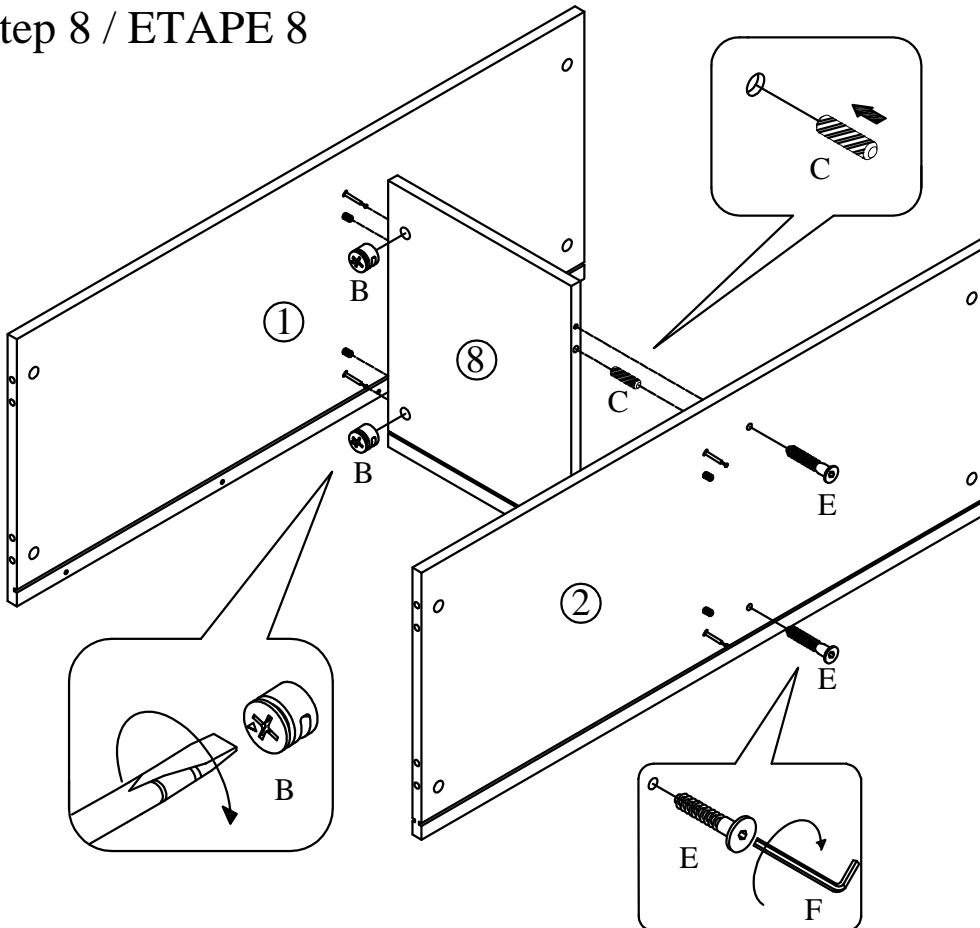

D	
4PCS	
K	
2PCS	
A	
1PC	

Step 8 / ETAPE 8



C	
2PCS	
E	
2PCS	
B	
2PCS	
F	
1PC	

Step 9 / ETAPE 9

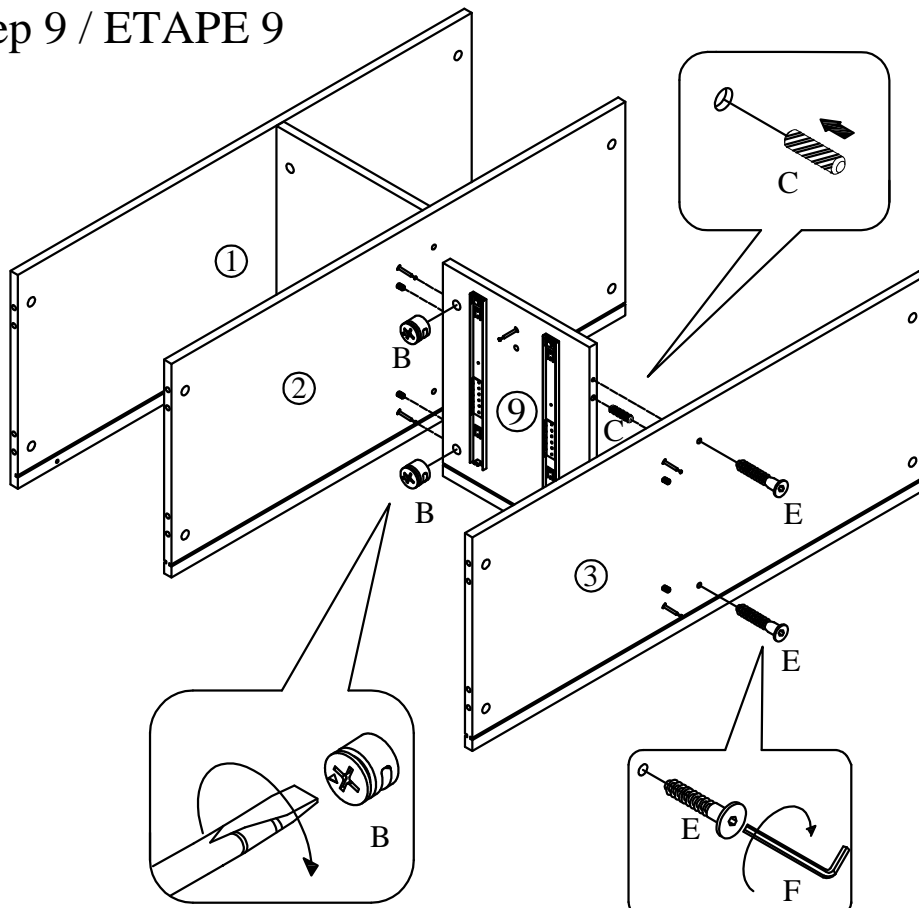

B	C
2PCS	2PCS
E	F
2PCS	1PC

Step 10 / ETAPE 10

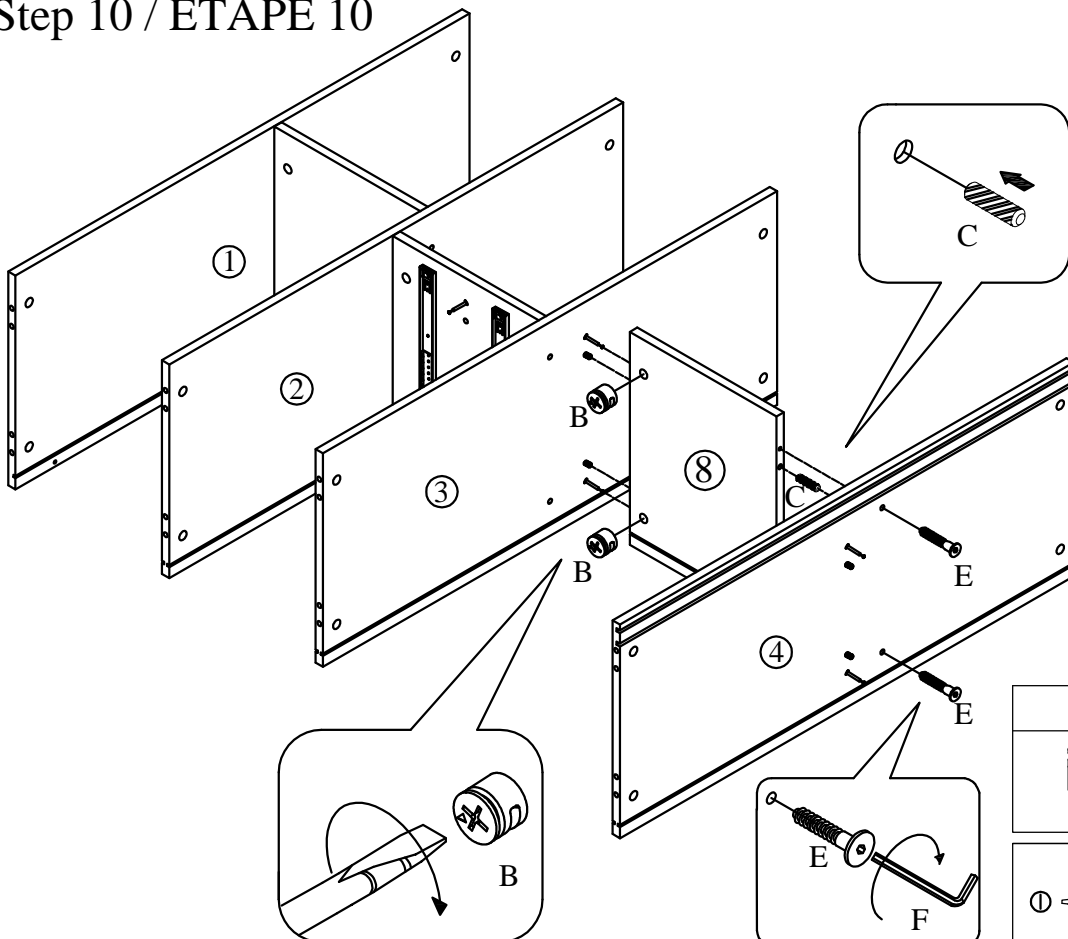

B	C
2PCS	2PCS
E	F
2PCS	1PC

Step 11 / ETAPE 11

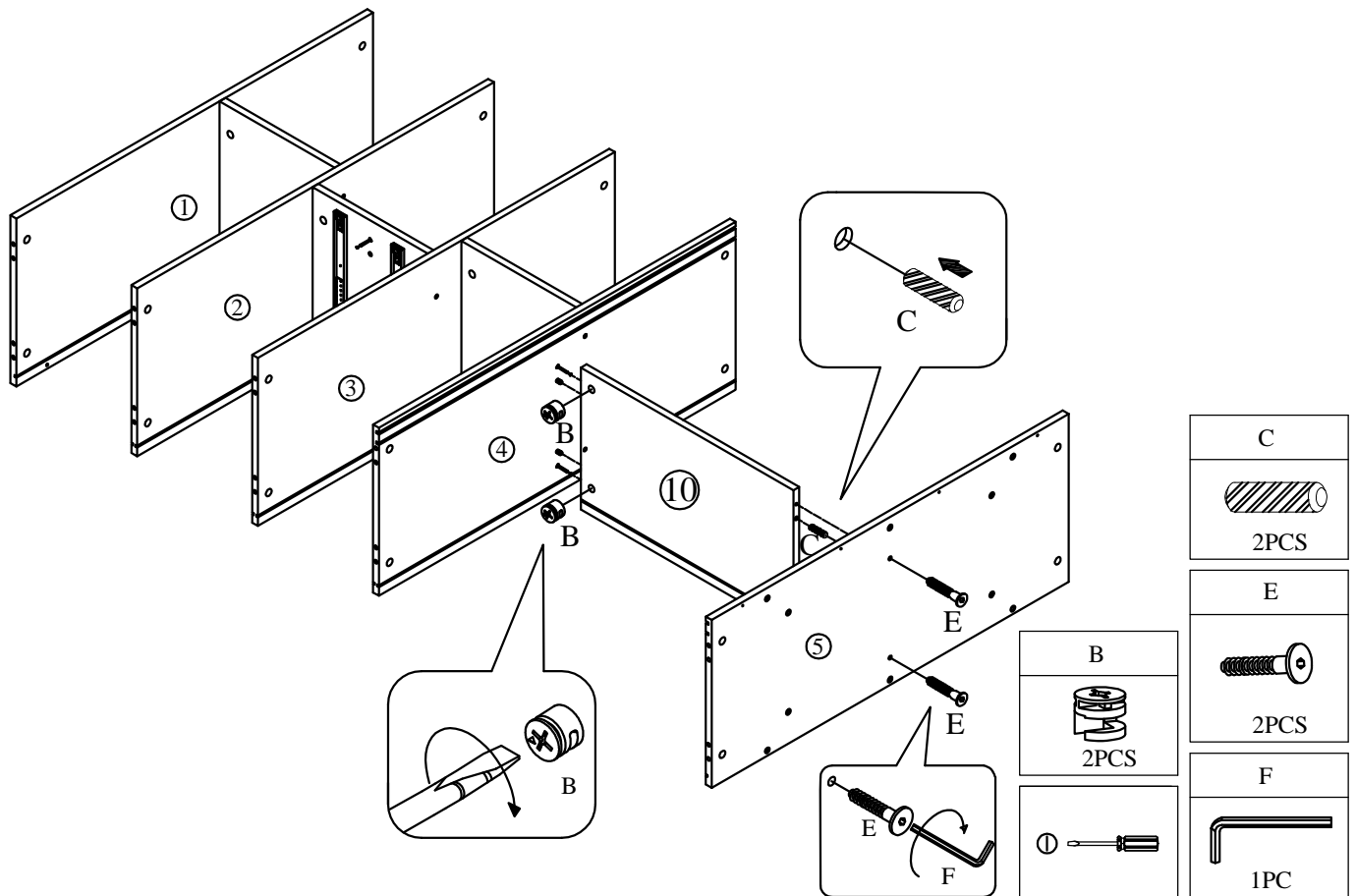

Step 12 / ETAPE 12

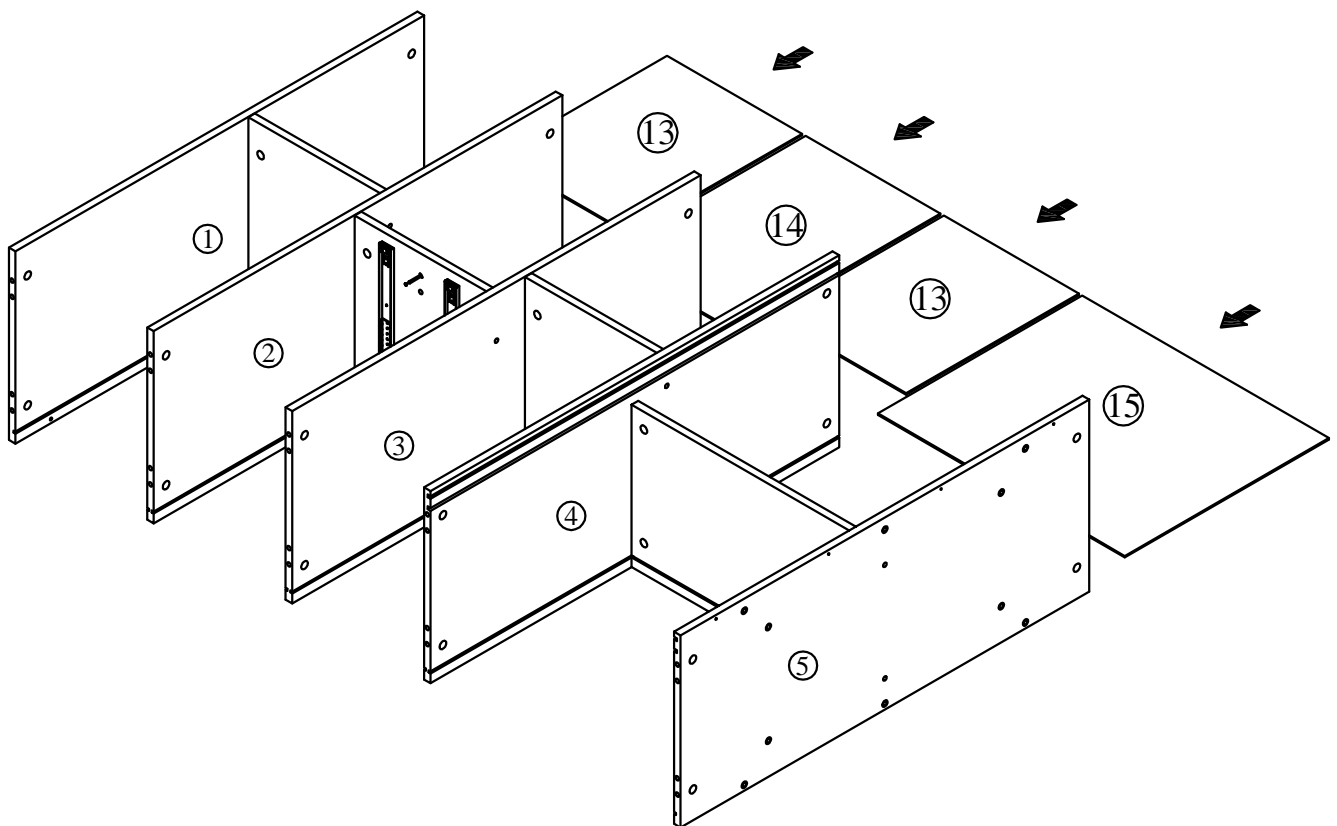

Step 13/ ETAPE 13

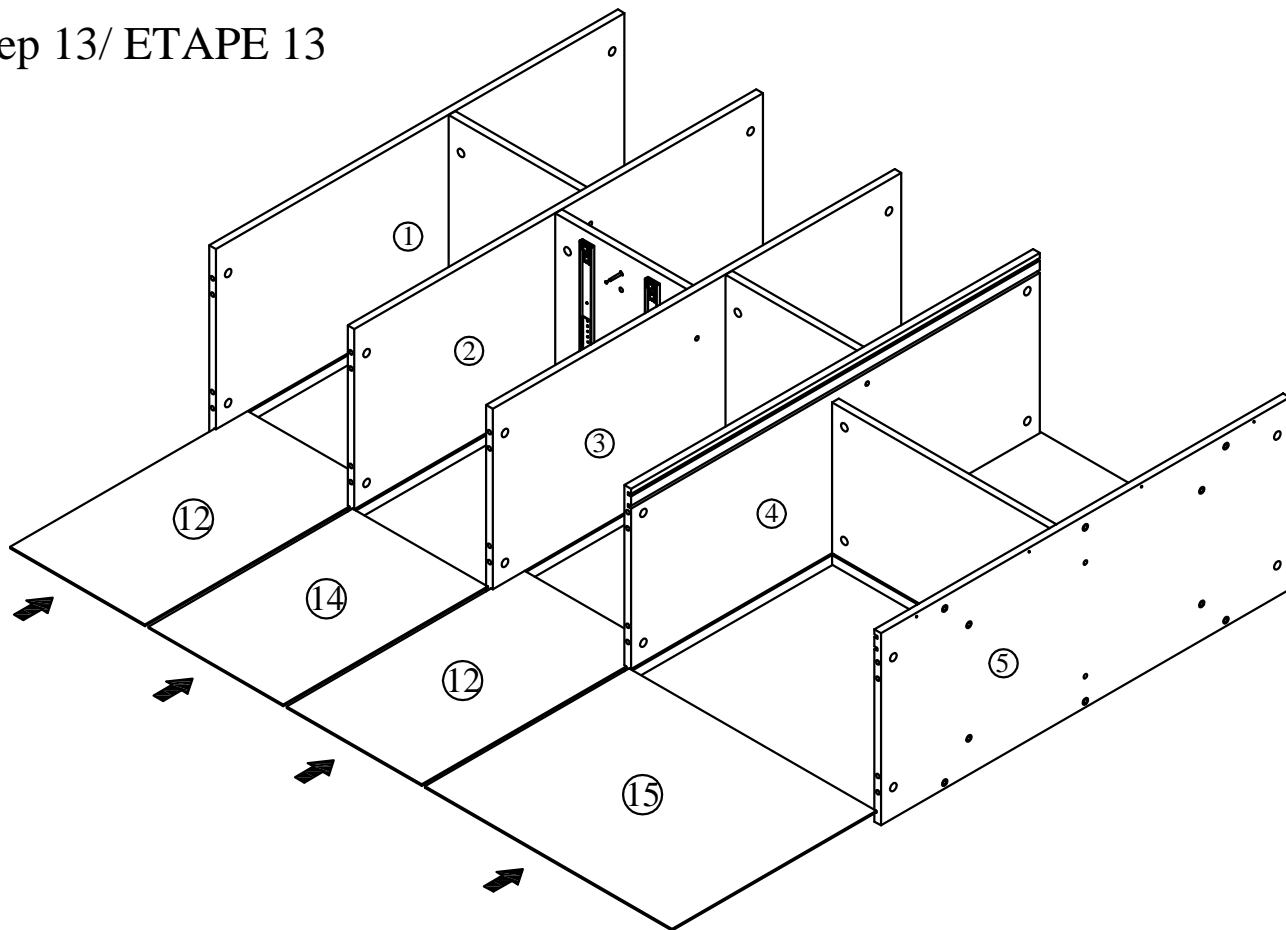

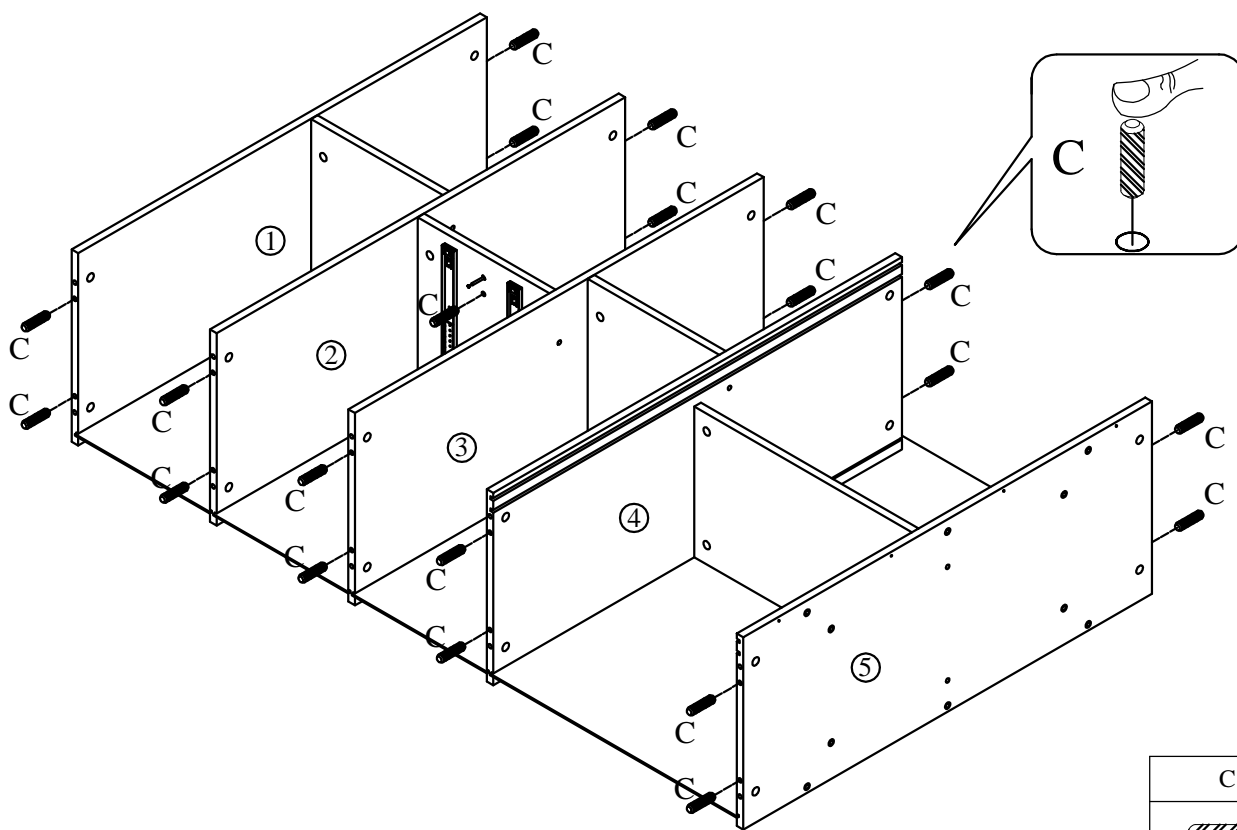

Step 14 / ETAPE 14

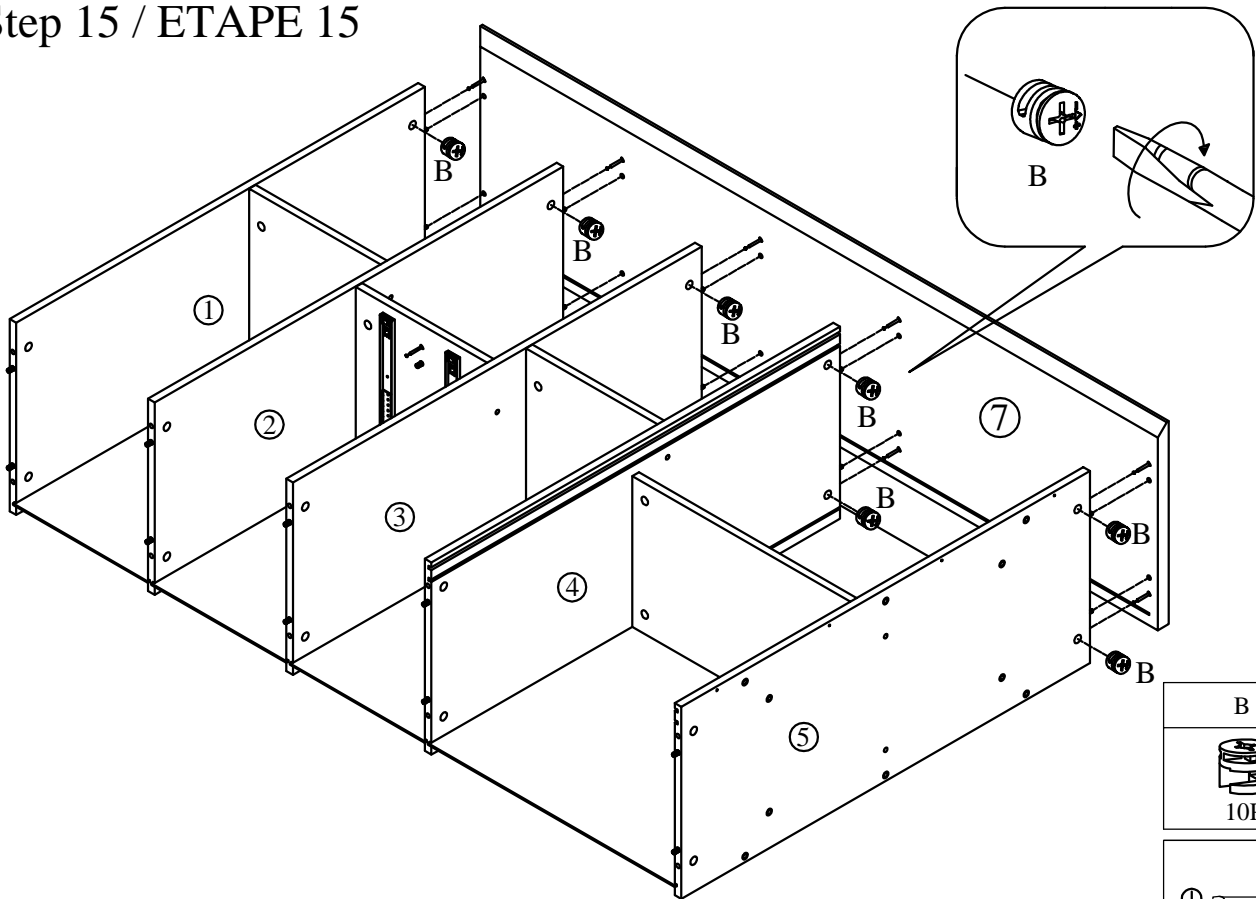

C

21PCS

Step 15 / ETAPE 15





B

10PCS

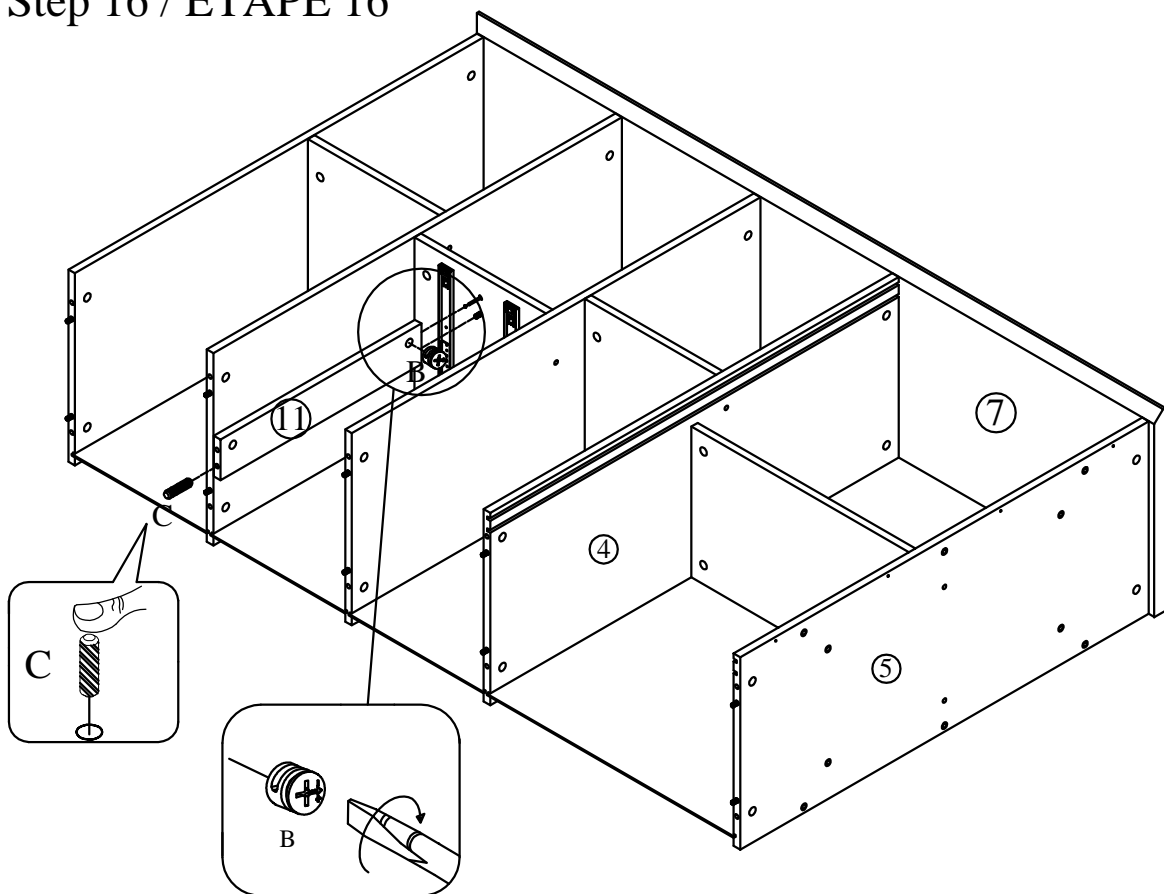
①	
---	---

Step 16 / ETAPE 16





C

1PC

B

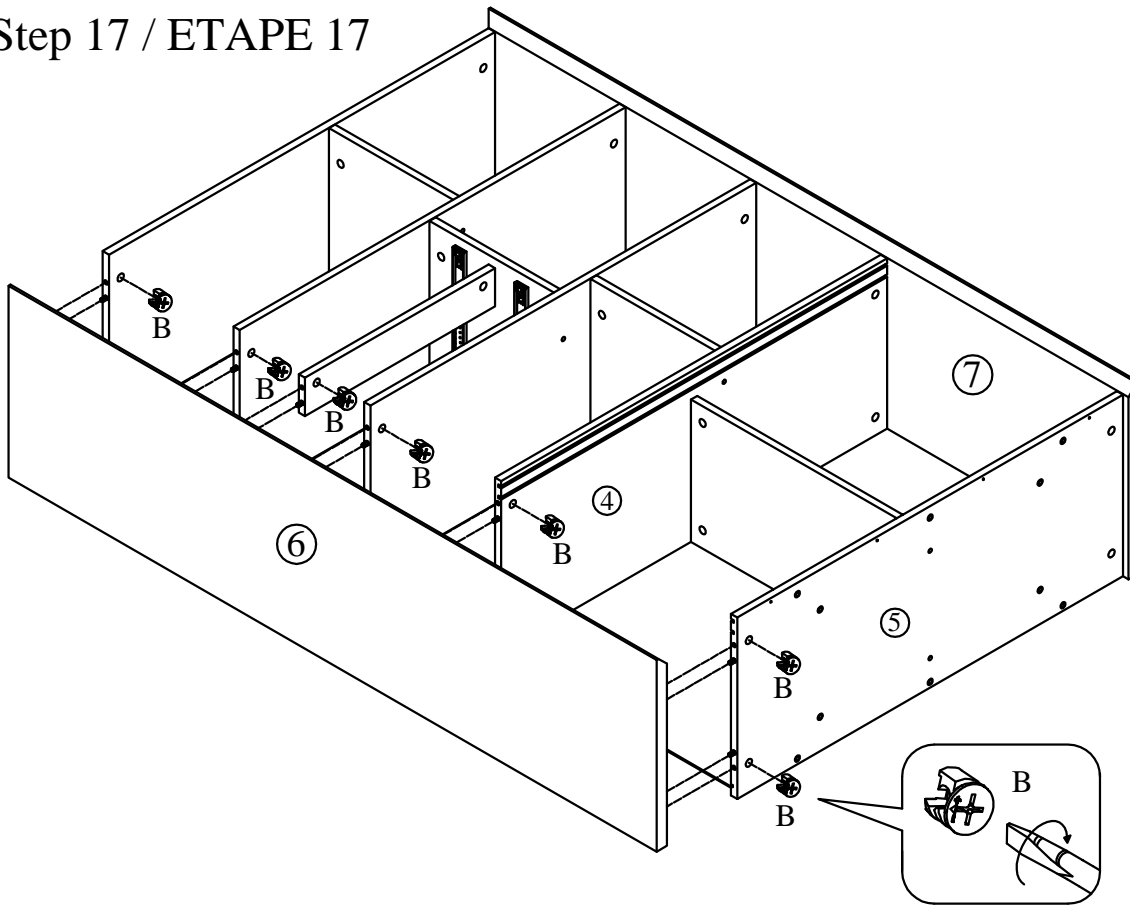
1PC

①	
---	---



Step 17 / ETAPE 17



B
 11PCS

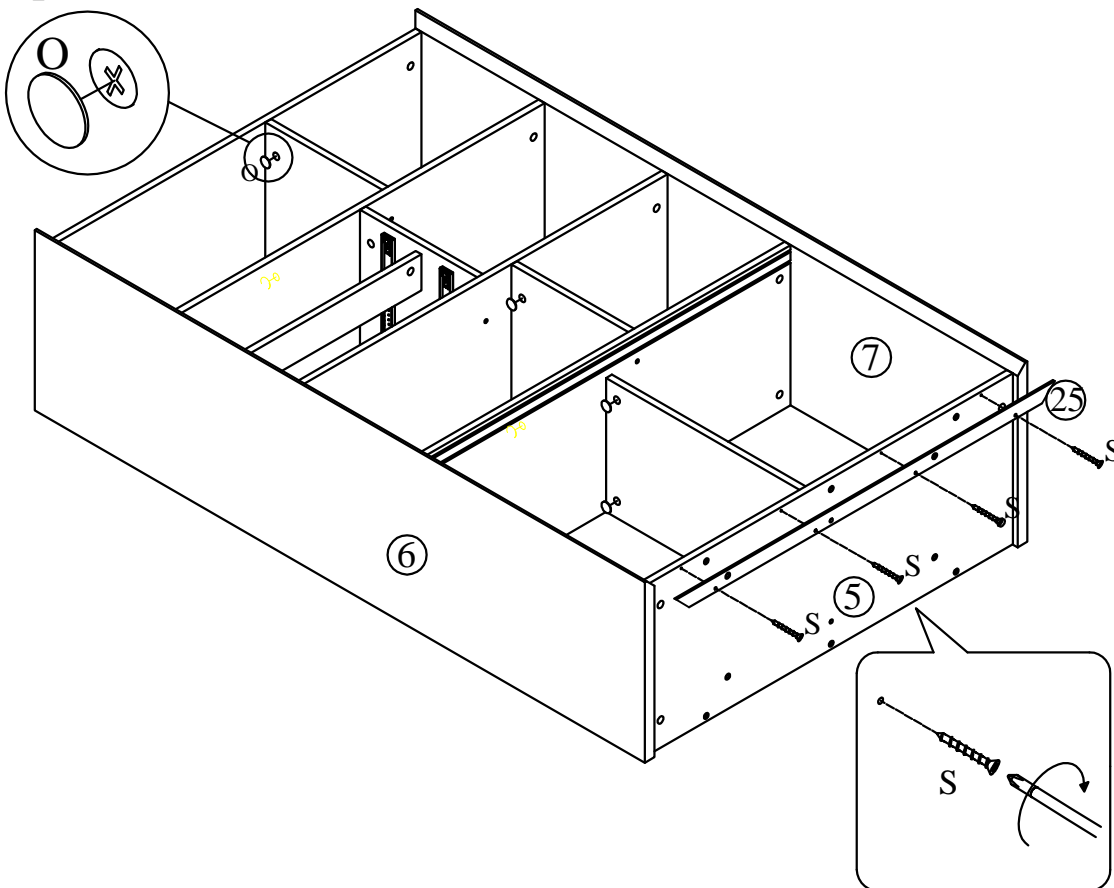

Step 18 / ETAPE 18



O
 6PCS
S
 4PCS

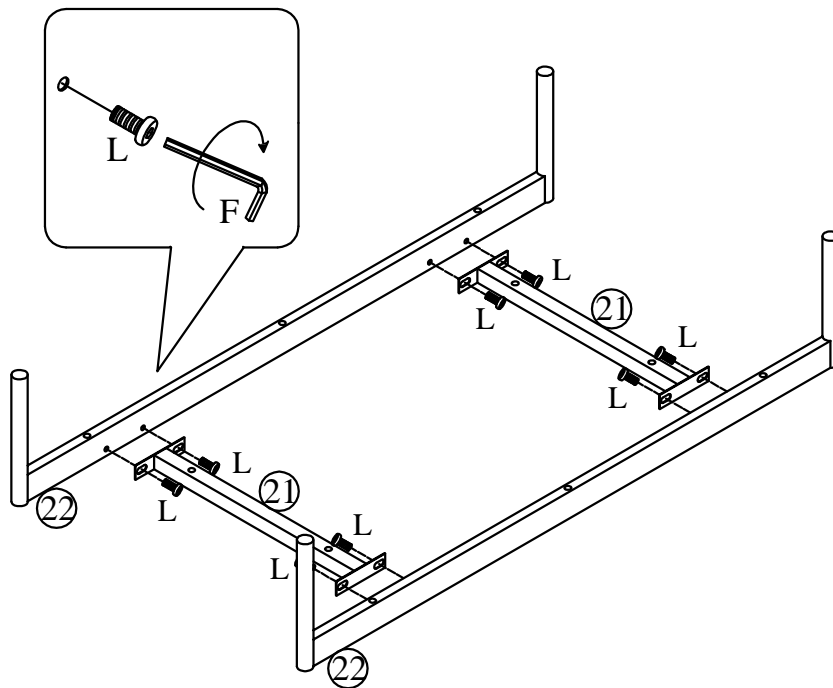



Step 19 / ETAPE 19

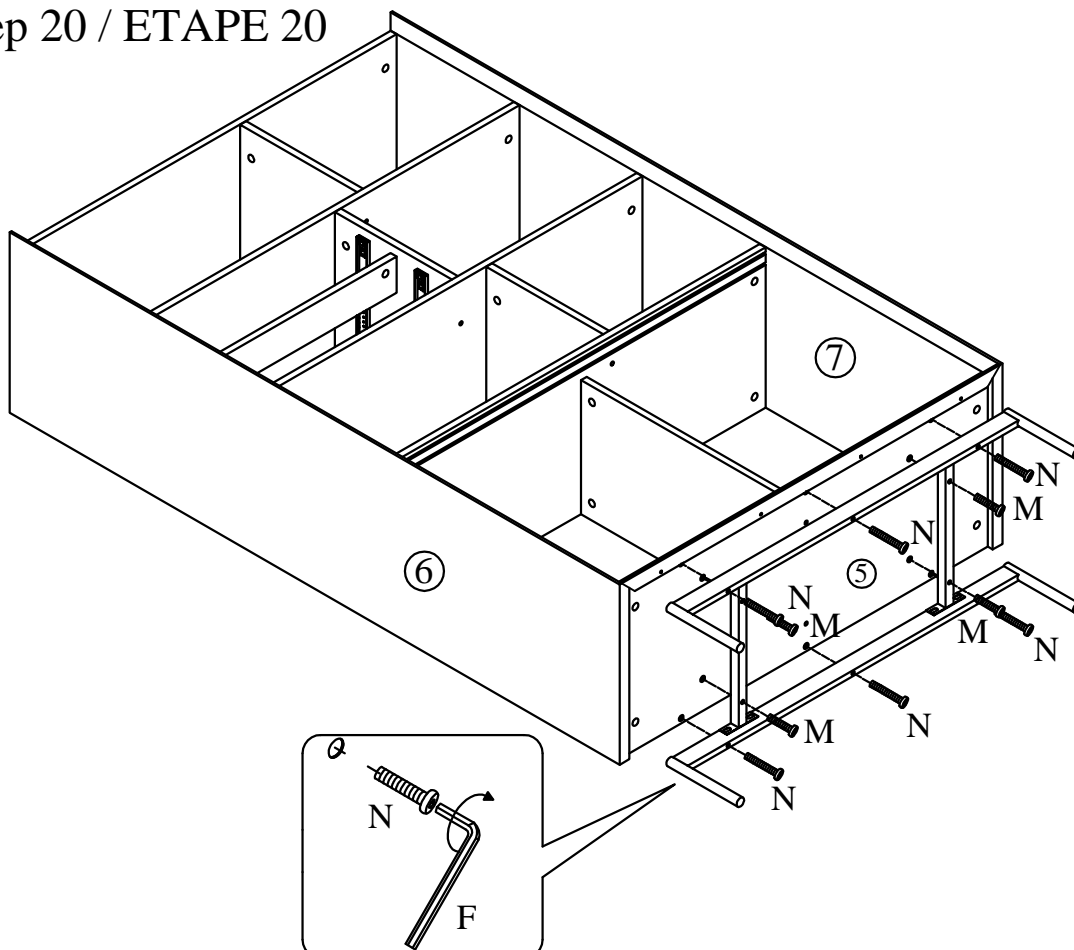

L

8PCS
F

1PC



Step 20 / ETAPE 20

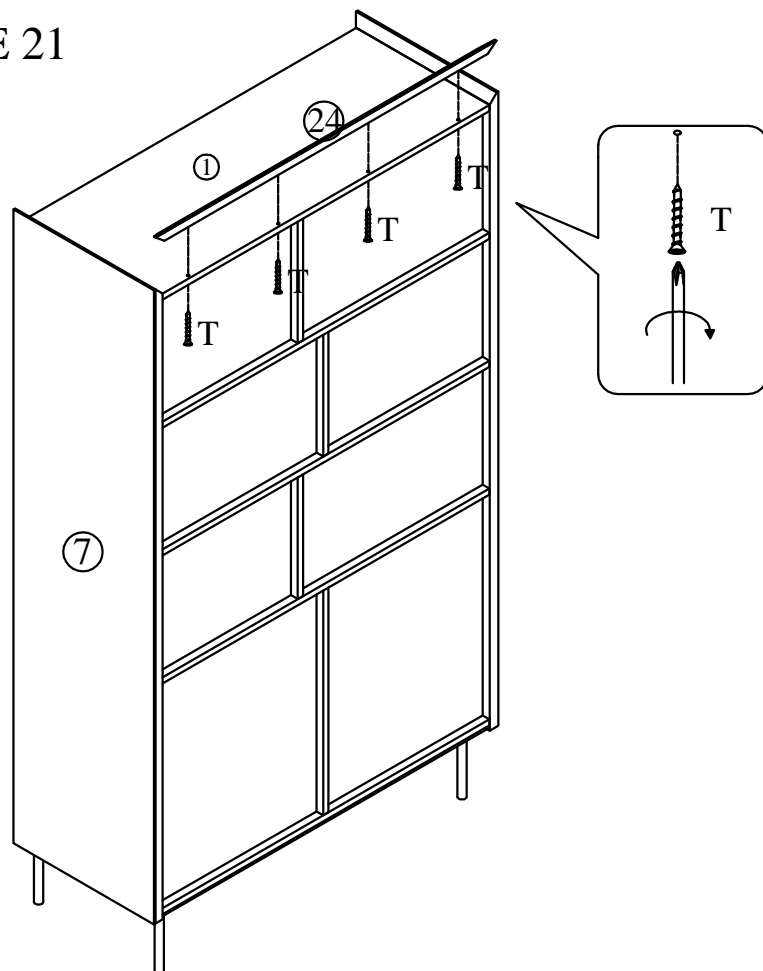

M

4PCS
N

6PCS
F

1PC

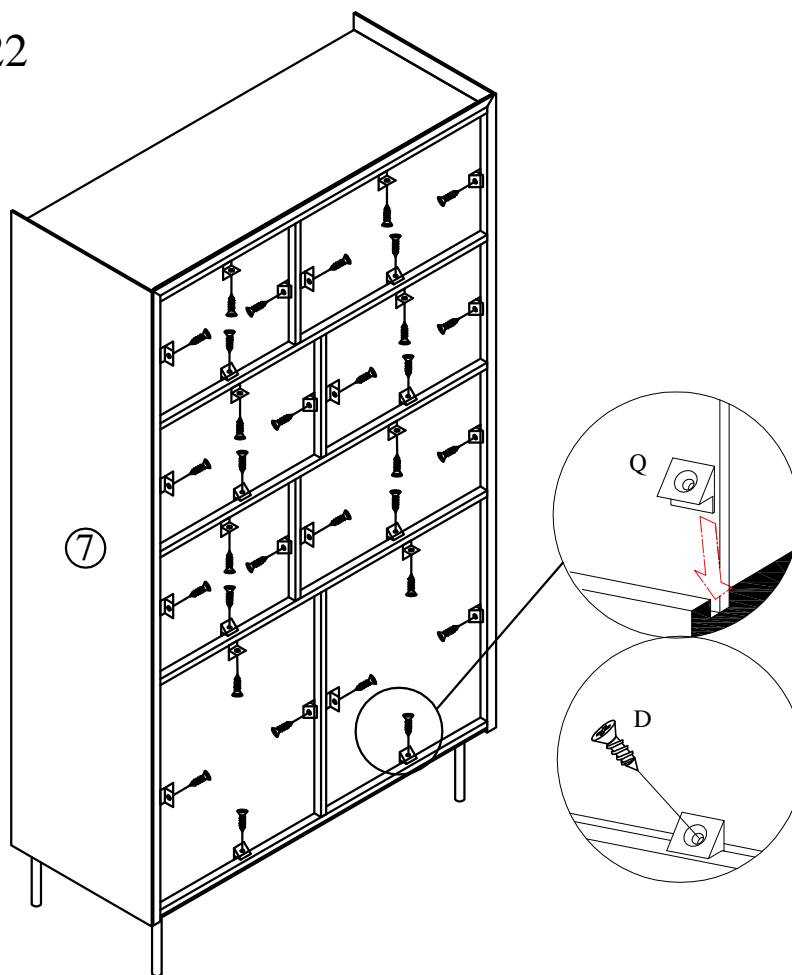

Step 21 / ETAPE 21



T

4PCS

Step 22 / ETAPE 22



D

32PCS
Q

32PCS



FIXATION MURALE OBLIGATORIE

UTILISEZ DES VIS ET DES CHEVILLES ADAPTEES A VOS MURS



Il existe une grande diversité de types de murs ou murs ou cloisons c'est la raison pour laquelle nous ne pouvons vous fournir une quincaillerie adaptée à votre mur. Il est nécessaire d'identifier le type de paroi à laquelle vous allez fixer ce produit afin de vous procurer les fixations appropriées. En cas de besoin, adressez vous à un magasin spécialisé pour conseil



OBLIGATORIO FIJAR A LA PARED

UTILICE LOS TORNILLOS Y TACOS ADECUADOS PARA SU MURO



Existe una gran diversidad de muros y paredes, por esta razón no podemos proporcionarle el herraje adecuado para su pared. Primero, es necesario identificar el tipo de pared para luego utilizar el herraje adecuado. En caso de duda, diríjase a una tienda especializada para más información.



OBLIGATORY FIX ON THE WALL

USE SCREWS AND PLUGS SUITABLES FOR YOUR WALL



Due to the wide diversity of wall or partition types, we cannot provide you with suitable attachment fixtures. To determine which attachment fixtures to use, you will need to identify the type of wall to which you will be fixing this product. If you have whatever doubt, please, go to one specialised shop for further information.

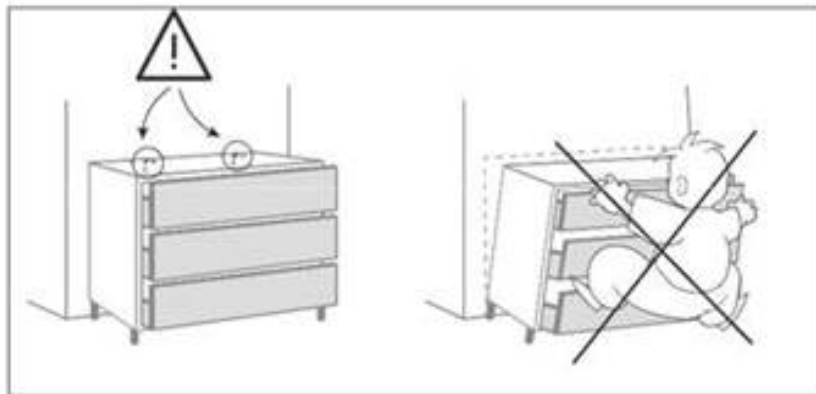

French

IMPORTANT: Pour éviter le basculement accidentel du meuble, la fixation du meuble au mur est obligatoire.

La visserie nécessaire pour la jonction mur/meuble, dépendante de la nature du mur, n'est pas fournie. En cas de doute, consulter un spécialiste

English

IMPORTANT: To avoid the accidental tip-over of the furniture, the fixing of the furniture on the wall is mandatory.

The needed hardware for the junction wall/furniture, depending of the nature of the wall, is not provided. If any doubt, consult a specialist.

Spanish

IMPORTANTE: Para evitar el vuelco accidental de los muebles, es obligatorio fijarlos en la pared.

El tipo de tornillos necesarios para fijar el mueble a la pared, dependen del material de la pared, no se suministran. En caso de duda, consulte a un especialista

Portuguese

IMPORTANTE: Para evitar a queda accidental de móveis, é obrigatorio fixá-los na parede. O tipo de parafusos para a fixação de mobiliário na parede, depende do material de parede e não são fornecidos. Em caso de dúvida, consulte um especialista.

Italian

IMPORTANTE: Per evitare il ribaltamento accidentale del mobile è obbligatorio il fissaggio a muro.

I tasselli necessari per il collegamento mobile\muro, dipendenti dal tipo di muro, non sono provvisti.

Consultare uno specialista in caso di dubbi

Croatian

VAŽNO: Kako bi se izbjeglo slučajno prevrtanje, namještaj je potrebno pričvrstiti na (uza) zid.

Različite vrste zidova zahtijevaju upotrebu različitih vrsta vijaka i tipli. Uvijek koristiti one koji su prikladni za vrstu zidova u domu. Vijci i tiple prodaju se zasebno.

U slučaju bilo kakvih sumnji, obratite se stručnjaku.

German

WICHTIG : Um ein versehentliches Kippen des Möbels zu vermeiden, ist die Befestigung an der Wand zwingend vorgeschrieben.

Die benötigten Schrauben zur Wandbefestigung, welche von der Beschaffenheit der Mauer abhängen, sind nicht in der Lieferung enthalten. Wenden Sie sich bitte bei Zweifel an einen Spezialisten.



Il existe une grande diversité de types de murs ou cloisons, c'est la raison pour laquelle nous ne pouvons vous fournir le type exact de fixation. Il est nécessaire d'identifier le type de paroi à laquelle vous allez fixer ce produit afin de vous procurer les fixations appropriées. Voici quelques exemples de fixations conseillées pour:



LES MURS PLEIS

Cheville nylon "FISCHER"

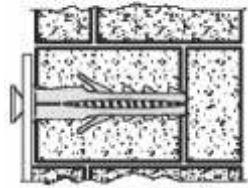
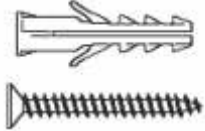

Cheville d'ancrage métal

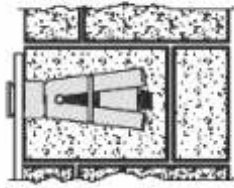
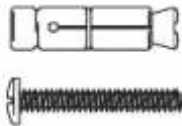

Cheville d'ancrage A ailettes en nylon

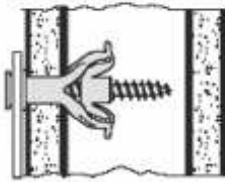
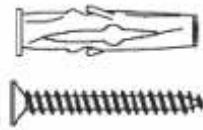

LES CLOISONS CREUSES

Cheville métallique A expansion

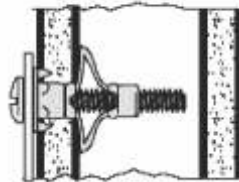
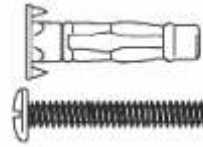

Cheville "MOLLY"

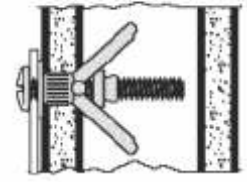
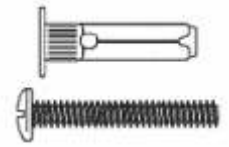

Utiliser une taille de forêt adaptée à la quincaillerie utilisée et au type de mur.



Es gibt eine Vielzahl verschiedener Arten von Mauern oder Zwischenwänden, und aus diesem Grunde können wir Ihnen den genau entsprechenden Befestigungstyp nicht bereitstellen. Zunächst ist es erforderlich, die exakte Bauart der Wand zu ermitteln, an der Sie dieses Produkt anbringen werden, um die für diese Wand geeigneten Befestigungsmittel im Fachhandel erwerben zu können. Nachfolgend einige Beispiele empfohlener Befestigungen für:



VOLLWÄNDE

NYLONDÜBEL „FISCHER“

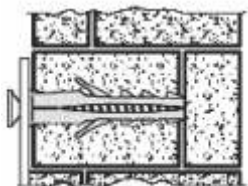
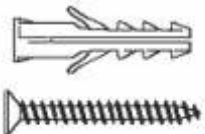

ANKERDÜBEL AUS METALL

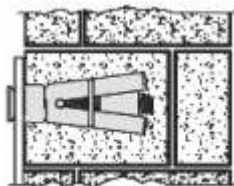
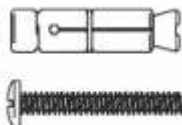

ANKERDÜBEL MIT NYLONFLÜGELN

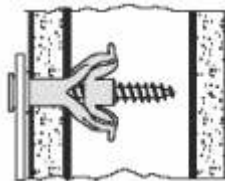
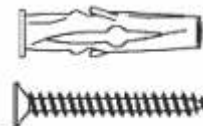

HOHLWÄNDE

SPREIZDÜBEL FÜR VERANKERUNG AUS METALL

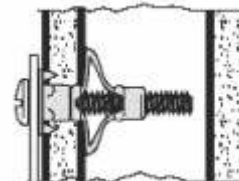
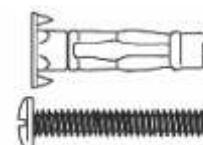

MOLLY-DÜBEL

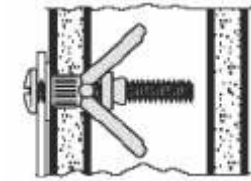
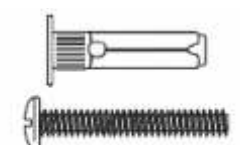

Bitte verwenden Sie eine für die Eisenwaren und den Wandtyp geeignete Bohrergröße.



Due to the wide diversity of wall or partition types, we cannot provide you with suitable attachment fixtures. To determine which attachment fixtures to use, you will need to identify the type of wall to which you will be fixing this product. Here are some examples of attachment fixtures recommended for:

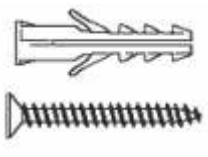
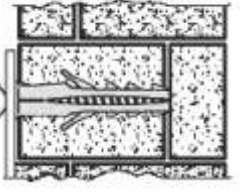
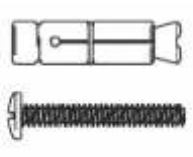
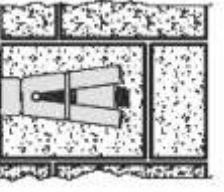
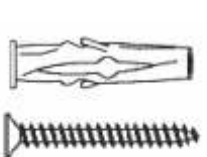
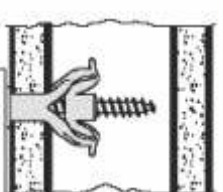
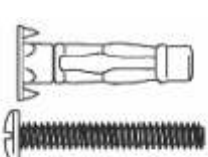
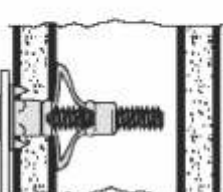
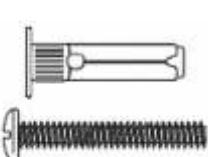
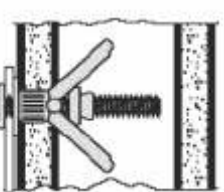

BLIND WALLS		STUDDED WALLS		
<p>"FISCHER" Nylon plug</p>  	<p>Metal Wall plug</p>  	<p>Nylon winged Wall plug</p>  	<p>Metal expansion plug</p>  	<p>"MOLLY" plug</p>  



Use a drill bit that is compatible in size with the hardware used and the type of wall.

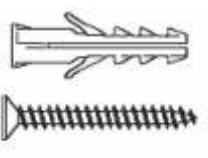
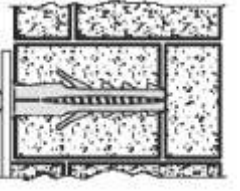
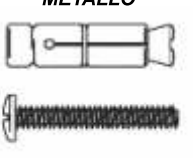
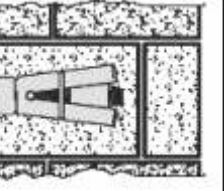
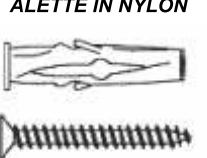
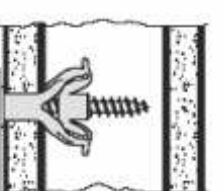
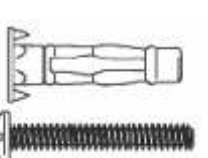
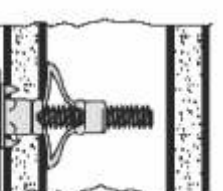

Esiste una gran varietà di tipi di muri o paratie e noi siamo in grado di fornirvi il tipo esatto di fissaggio per ognuno di essi. E' necessario identificare il tipo di parete alla quale intendete fissare questo prodotto in modo da fornirvi i fissaggi più idonei. Ecco qualche esempio di fissaggi consigliati per :

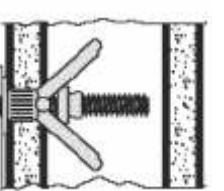
I MURI PIENI		PARATIE CAVE		
<p>TASSELLO NYLON "FISCHER"</p>  	<p>TASSELLO DI ANCORAGGIO IN METALLO</p>  	<p>TASSELLO DI ANCORAGGIO AD ALETTE IN NYLON</p>  	<p>TASSELLO METALLICO AD ESPANSIONE</p>  	<p>TASSELLO "MOLLY"</p>  



Utilizzare una punta di trapano adatta agli utensili utilizzati e al tipo di muro.

Step 23 / ETAPE 23

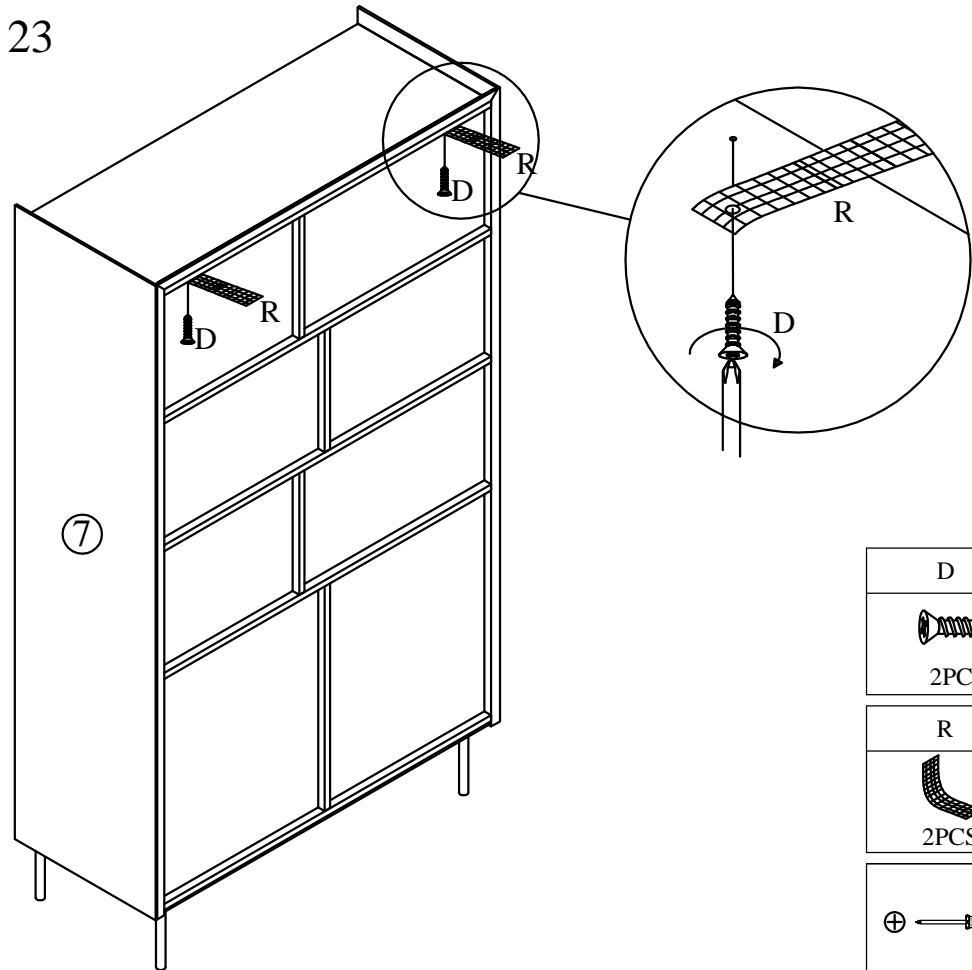

Step 24 / ETAPE 24

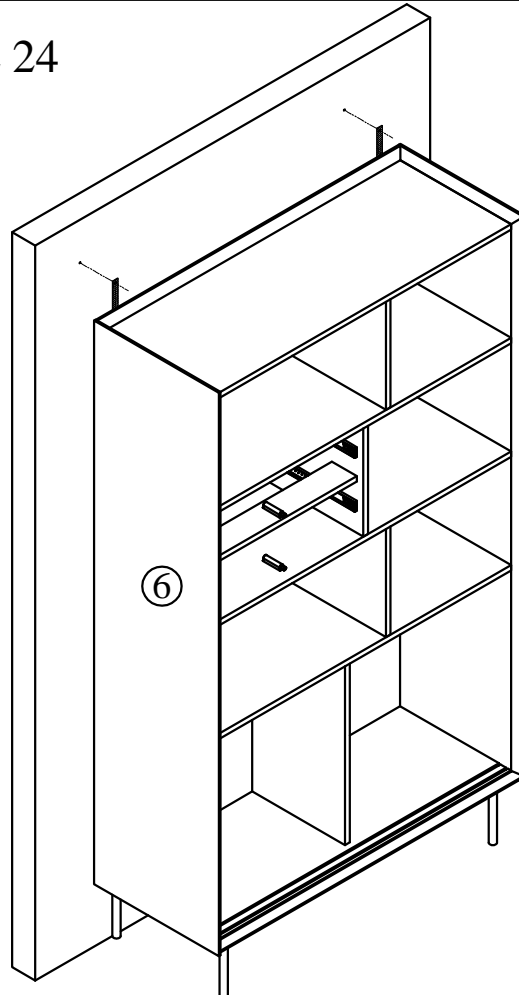

FIXATION MURALE OBLIGATORIE
OBLIGATORIO FIJAR A LA PARED
OBLIGATORY FIX ON THE WALL

Step 25 / ETAPE 25

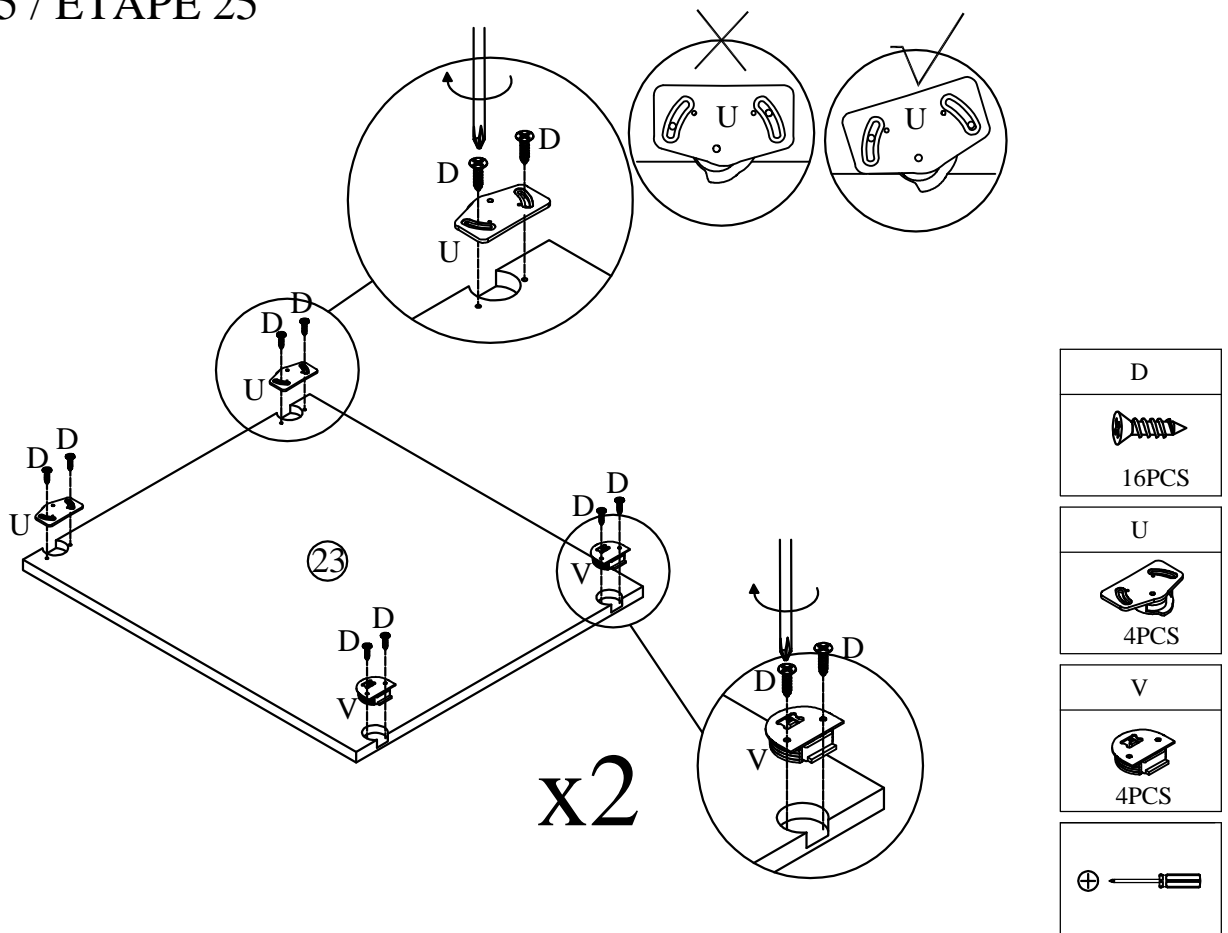

Step 26 / ETAPE 26

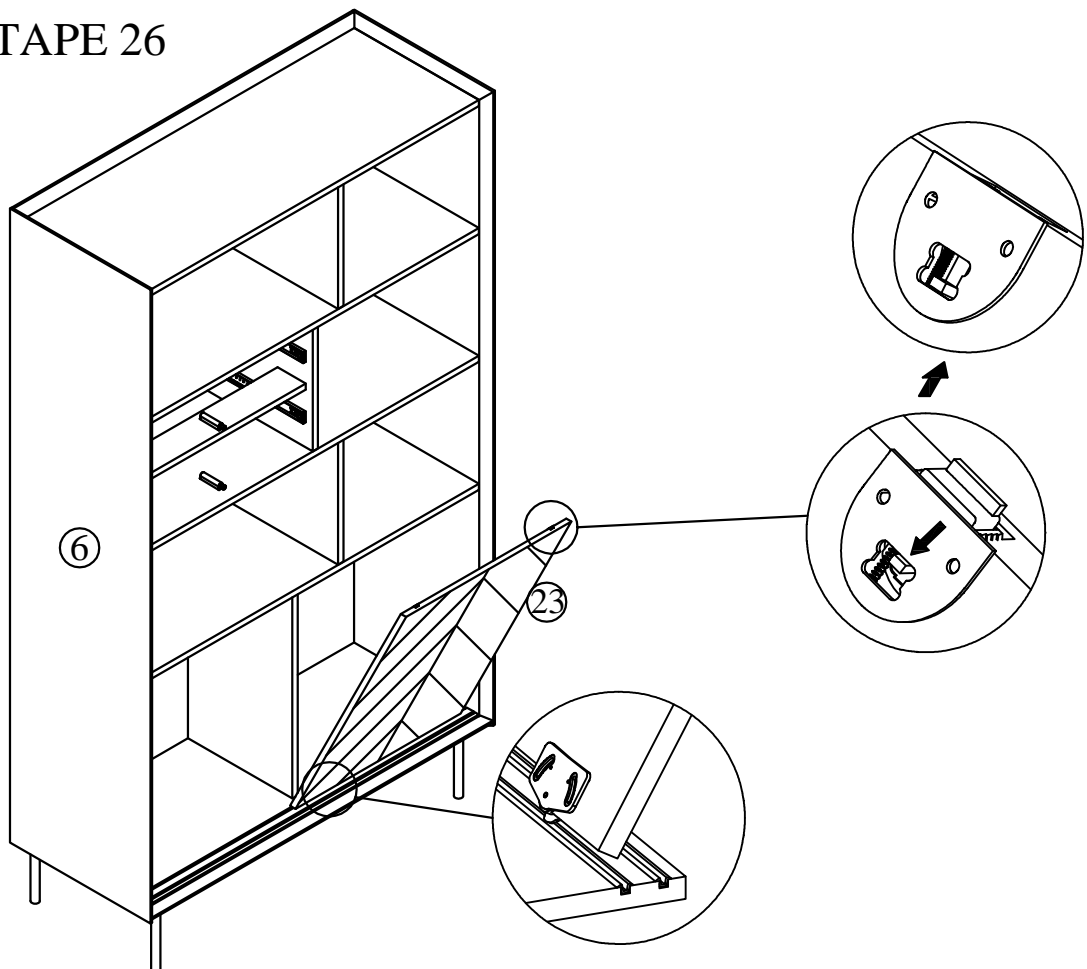

Step 27 / ETAPE 27

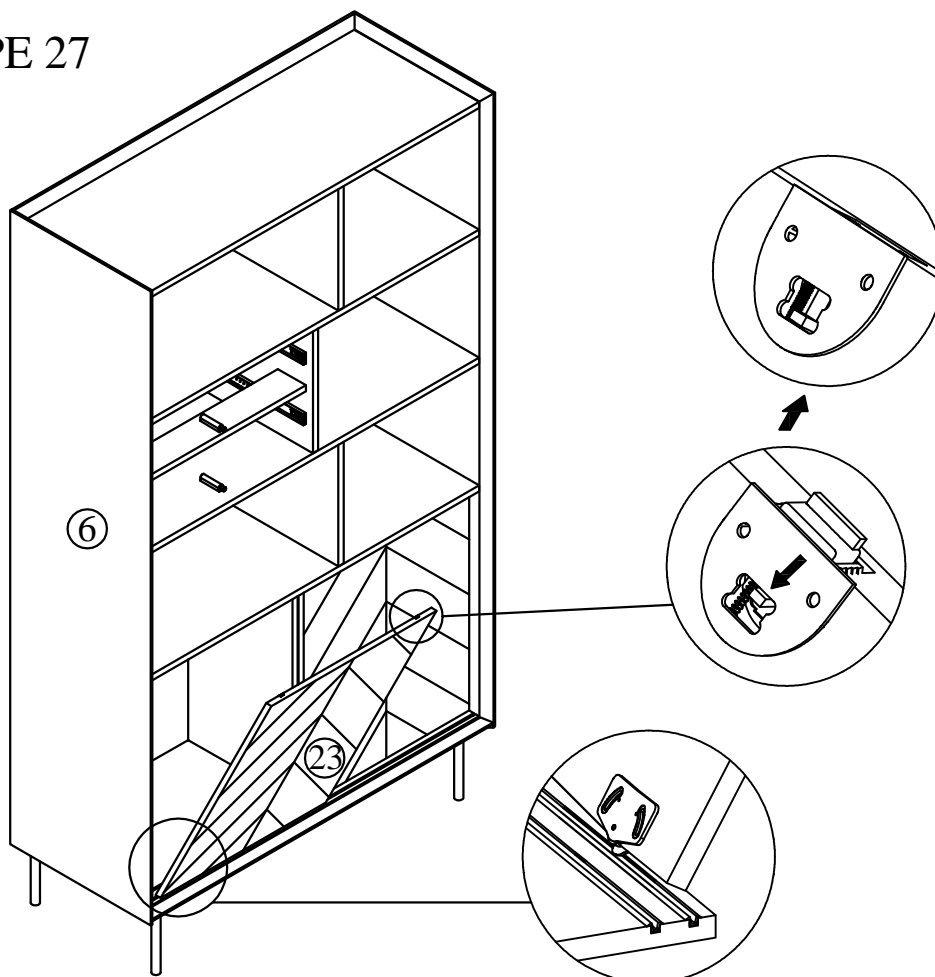

Step 28 / ETAPE 28

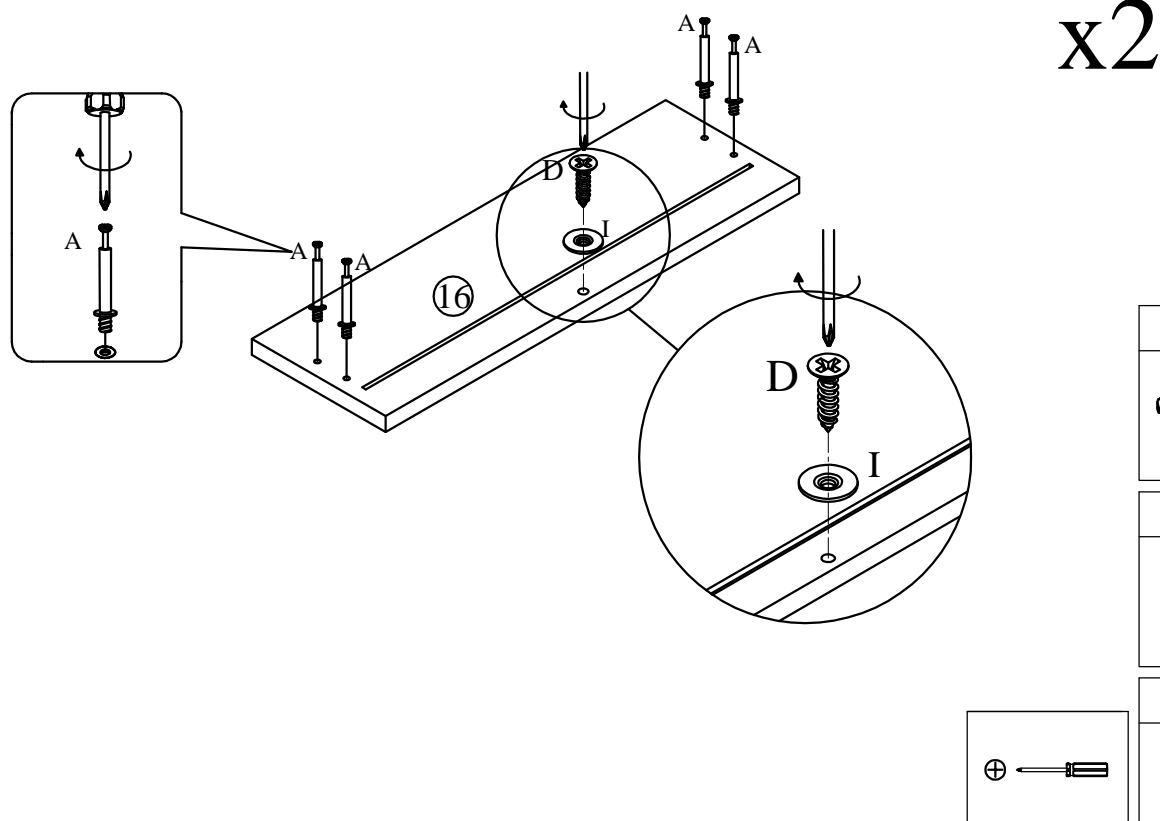

Step 29 / ETAPE 29

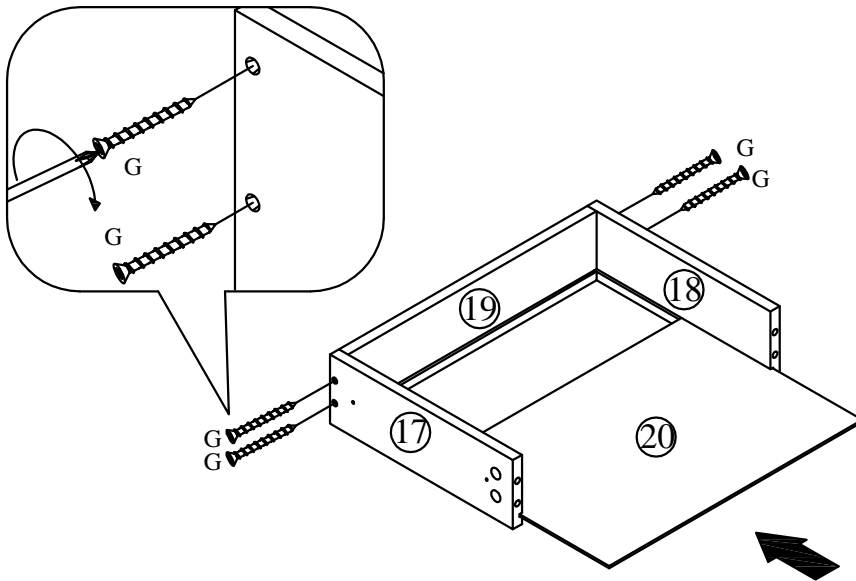

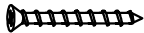
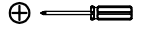

x2

G

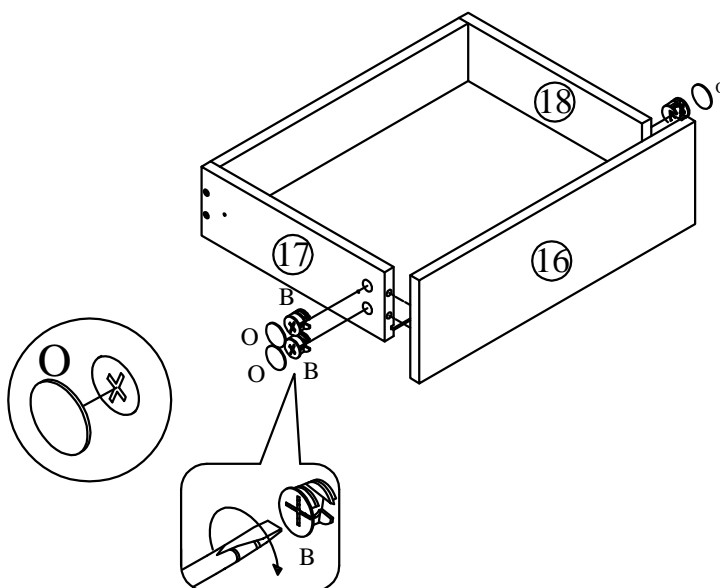
8PCS

Step 30 / ETAPE 30







x2

B

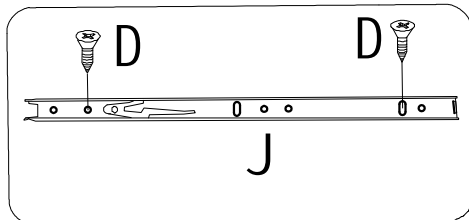
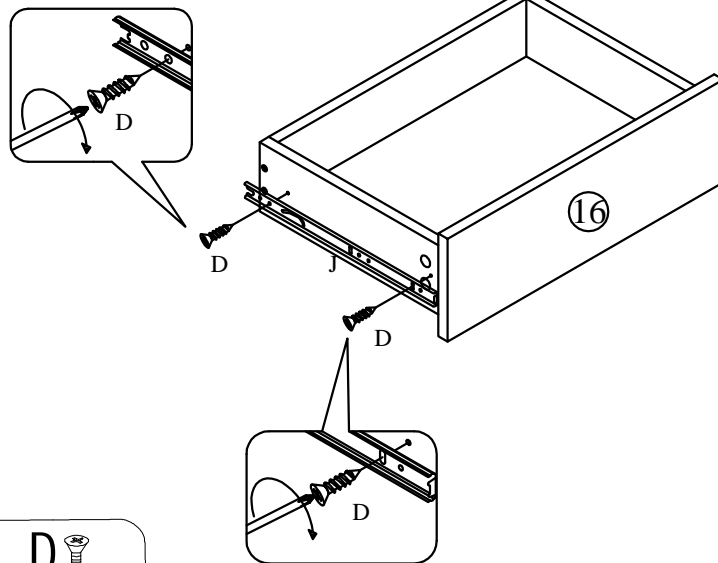
8PCS
O

8PCS

Step 31 / ETAPE 31

x2



D

8PCS
J

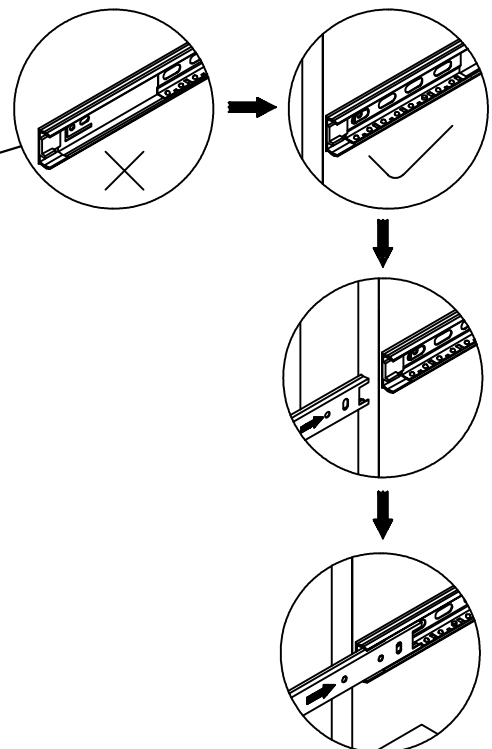
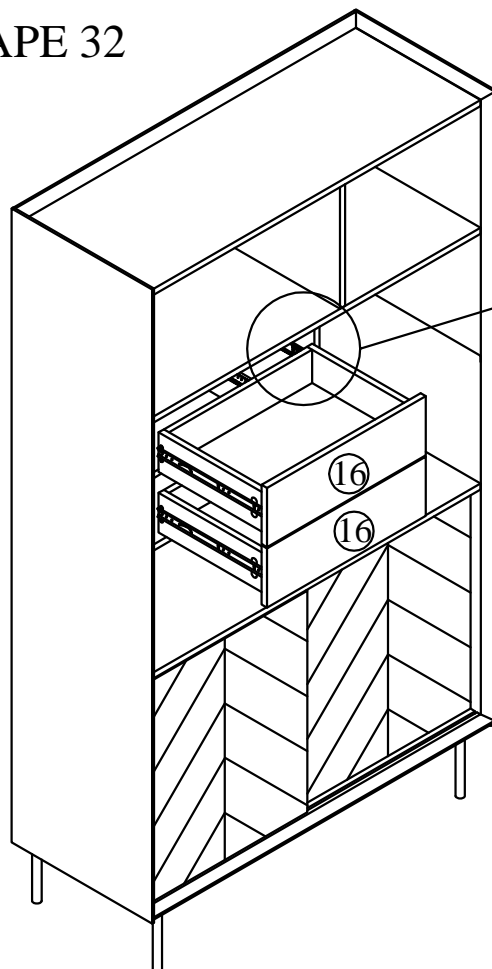
4PCS

Step 32 / ETAPE 32

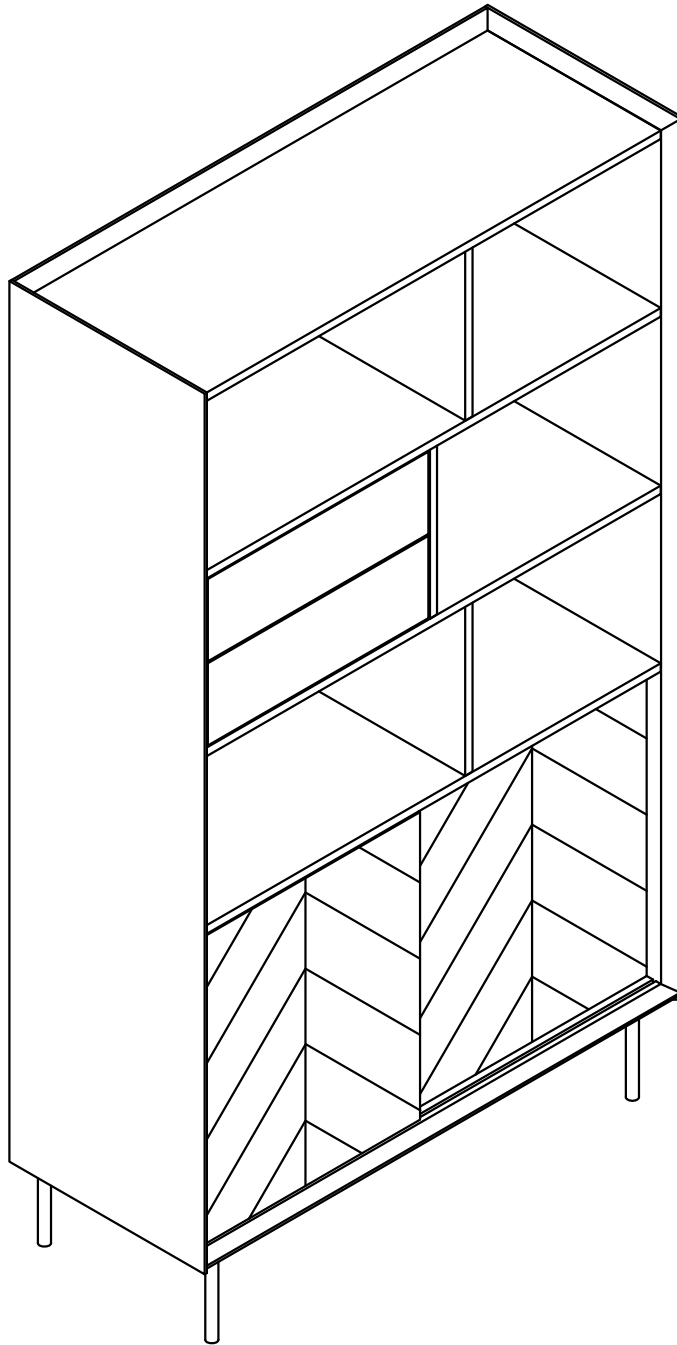

Step 33 / ETAPE 33



FRENCH: "Les meubles contenant des panneaux à base de bois (panneaux de particules, panneaux de fibres, contreplaqué...) peuvent émettre des substances polluantes dans l'air intérieur. Il est ainsi recommandé, après l'installation du meuble dans son logement, d'aérer fréquemment la pièce concernée pendant au moins quatre semaines afin de réduire son exposition aux polluants émis par le meuble."

SPANISH: Los muebles que contienen paneles a base de madera (Aglomerado, cartón, contrachapado ...) pueden emitir sustancias contaminantes en el aire. Por lo tanto, se recomienda airear frecuentemente los muebles al menos durante cuatro semanas después de su instalación para reducir su exposición a los contaminantes emitidos por los muebles.

ENGLISH: Furniture containing wood-based panels (Particle board, fibreboard, plywood ...) could emit pollutants on the air. Therefore, it is advisable to ventilate the furniture at least during four weeks after its assembly in order to reduce the exposure to the pollutants released by the furniture.

FRANCAIS - SUISSE

CONSEILS DE MONTAGE :

- 1 > BIEN ETUDIER LA NOTICE DE MONTAGE.
- 2 > REPEREZ LES PIÈCES CONSTITUANT VOTRE MEUBLE.
- 3 > REGROUPEZ ET CONTROLEZ LA QUINCAILLERIE.
- 4 > MUNISSEZ-VOUS DE L'OUTILLAGE NECESSAIRE.
- 5 > AMENAGEZ-VOUS UNE ZONE DE MONTAGE.
- 6 > PROCEDEZ AU MONTAGE.



**NE JAMAIS FORCER LES ASSEMBLAGES.
RESSERREZ LES VIS APRES QUELQUES TEMPS D'USAGE.
GARDER VOTRE NOTICE DE MONTAGE, SI UNE PIÈCE
VENAIT A MANQUER, ELLE SERAIT LE PLUS CLAIR
MOYEN DE COMMUNIQUER AVEC VOTRE MAGASIN.**

CONSEILS D'ENTRETIEN :

- 1 > DÉPOUSSIÉREZ SOIGNEUSEMENT.
- 2 > UTILISEZ UN CHIFFON SEC.



**- NE JAMAIS UTILISER
DE PRODUITS ABRASIFS:
POUDRE, LAINE D'ACIER, SOLVANTS.
- NE PAS MOUILLER**

	PAPIER DECOR	SURFACES STRATIFIÉES	SURFACES LAQUÉES	BOIS VERNIS	TEXTILE CUIR
EAU SAVONNEUSE (SAVON NEUTRE)	<input type="radio"/>	<input type="radio"/>	<input type="radio"/>	<input type="radio"/>	<input type="radio"/>
EAU ADDITIO NÉE		<input type="radio"/>	<input type="radio"/>		
ENTRETIEN SPÉCIFIQUE FABRICANT					<input type="radio"/>

DEUTSCH - SCHWEIZ

MONTAGE ANLEITUNG:

- 1 > DIE MONTAGEANLEITUNG SORGFÄLTIG DURCHLESEN.
- 2 > DIE EINZELTEILE DES MÖBELSTÜCKS ERMITTELN.
- 3 > DIE BESCHLÄGE ZUSAMMENLEGEN UND PRÜFEN.
- 4 > DAS NOTWENDIGE WERKZEUG ZURECHTLEGEN.
- 5 > EINEN MONTAGEBEREICH FREIMACHEN.
- 6 > DAS MÖBELSTÜCK ZUSAMMENBAUEN.



**NIEMALS DIE VERBINDUNGEN ZU STARK ANZIEHEN.
DIE SCHRAUBEN NACH EINIGER ZEIT DES GEBRAUCHS
ERNEUT FESTZIEHEN. DIE MONTAGEANLEITUNG
GUT AUFBEWAHREN: SOLLTE EIN TEIL FEHLEN, IST SIE DAS
BESTE VERSTÄNDIGUNGSMITTEL MIT IHREM GESCHÄFT.**

PFLEGEHINWEISE :

- 1 > SORGFÄLTIG ENTSTAUBEN.
- 2 > VERWENDEN SIE EIN TROCKENES TUCH.



**- BENUTZEN SIE KEINE
SCHEUERMITTEL WIE PULVER,
STAHLWOLLE, LÖSUNGSMITTEL.
- KEIN WASSER VERWENDEN.**

	DEKORPAPIER	OBERFLÄCHE LAMINAT	OBERFLÄCHE LACK	LACKIERTEM HOLZ	TEXUL LEDER
SEIFENLAUGE (NEUTRALSEIFE)	<input type="radio"/>	<input type="radio"/>	<input type="radio"/>	<input type="radio"/>	<input type="radio"/>
WASSER MIT HAUSHALTSRFINIGER		<input type="radio"/>	<input type="radio"/>		
PRODUZENT SPEZIFISCHER UNTERHALT					<input type="radio"/>

ITALIANO - SVIZZERA

CONSIGLI DI MONTAGGIO

- 1 > STUDIARE BENE LE ISTRUZIONI DI MONTAGGIO.
- 2 > PRENDERE CONOSCENZA DEI PEZZI CHE COSTITUISCONO IL MOBILE.
- 3 > RAGGRUPPARE E CONTROLLARE LA FERRAMENTA.
- 4 > MUNIRSI DEGLI UTENSILI NECESSARI.
- 5 > PREPARARE UNA ZONA DI MONTAGGIO.
- 6 > PROCEDERE AL MONTAGGIO.



**NON FORZARE MAI GLI ASSEMBLAGGI
RISTRINGERE LE VITI DOPO UN PERIODO D'USO
CONSERVARE QUESTE ISTRUZIONI DI MONTAGGIO,
SE UN PEZZO VENISSE A MANCARE SAREBBE IL MIGLIORE
MEZZO DI COMUNICAZIONE CON IL RIVENDITORE**

CONSIGLI PER LA MANUTENZIONE :

- 1 > SPOLVERATE ACCURATAMENLE.
- 2 > USARE UN PANNINO ASCIUTTO.



**- NON UTILIZZARE MAI PRODOTTI
ABRASIVI: POLVERE,
LANA DI ACCIAIO, SOLVENTI.
- NON BAGNARE.**

	CARTA	SUPERFICIE STRATIFICATE	SUPERFICIE LACCATE	LACCATE EGNO VERNICIATO	TESSILE CUIRO
ACQUA CON SAPONE (SAPONE NEUTRO)	<input type="radio"/>	<input type="radio"/>	<input type="radio"/>	<input type="radio"/>	<input type="radio"/>
ACQUA CON DETERSIVO SAN MARC		<input type="radio"/>	<input type="radio"/>		
MANUTENZIONE SPECIFICA PRODUTTORE					<input type="radio"/>

PORTUGUÊS

CONSELHOS DE MONTAGEM:

- 1 > ESTUDE BEM AS INSTRUÇÕES DE MONTAGEM.
- 2 > REUNA AS PEÇAS QUE CONSTITUEM O SEU MÓVEL.
- 3 > REAGRUPE AS FERRAGENS.
- 4 > EQUIPE-SE COM AS FERRAMENTAS NECESSÁRIAS.
- 5 > PREPARE UMA ÁREA PARA A MONTAGEM.
- 6 > INICIE A MONTAGEM.



**NUNCA FORÇAR OS ENCAIXES.
REAPERTAR OS PARAFUSOS APÓS UM TEMPO DE UTILIZAÇÃO.
GUARDAR AS INSTRUÇÕES DE MONTAGEM.
CASO FALTE ALGUMA PEÇA, O MAIS ACONSELHÁVEL
É CONTATAR O REVENDEDOR.**

CONSELHOS PARA A MANUTENÇÃO :

- 1 > ELIMINAR BEM O PÓ.
- 2 > USAR PANO SECO.



**- NUNCA UTILIZAR PRODUTOS
ABRASIVOS: SAPONÁCEOS,
LÃ DE AÇO, SOLVENTES.
- NÃO MOLHAR .**

	ACABAMENTO IMITAÇÃO	SUPERFÍCIES ESTRATIFICADAS	SUPERFÍCIES LACADAS	MADEIRA ENVERNIZADA	TEXTEIS PELES
ÁGUA COM SABÃO (SABÃO NEUTRO)	○	○	○	○	○
ÁGUA COM DETERGENTE		○	○		
INSTRUÇÕES ESPECÍFICAS DO FABRICANTE					○

ESPAÑOL

CONSEJOS PARA EL MONTAJE:

- 1 > ESTUDIE ATENTAMENTE EL MANUAL DE MONTAJE.
- 2 > LOCALICE LAS PIEZAS QUE CONSTITUYEN SU MUEBLE.
- 3 > REUNA Y CONTROLE LOS TORNILLOS.
- 4 > EQUIPE-SE DE LAS HERRAMIENTAS NECESARIAS.
- 5 > PREPARE UNA ZONA DE MONTAJE.
- 6 > REALICE EL MONTAJE.



**NO FUERCE NUNCA EN LAS UNIONES. APRIETE LOS
TORNILLOS DESPUES DE CIERTO TIEMPO DE UTILIZACION
CONSERVE SU MANUAL DE MONTAJE,
SI FALTARA UNA PIEZA, SERIA LA MANERA
MAS FACIL DE COMUNICAR CON LA TIENDA.**

CONSEJOS PARA EL MANTENIMIENTO:

- 1 > DESPOLVOREAR CULDAOSAMENTE.
- 2 > UTILICE UN PAÑO SECO.



**- NO USE NUNCA PRODUCTOS
ABRASIVOS TALES COMO:
POLVO DE LIMPIAR,
LANA DE ACERO, SOLVENTES.
- NO MOJAR.**

	PAPEL DE DECORACION	SUPERFICIE ESTRATIFICADAS	SUPERFICIE MAQUEADAS	MADERA BARNIZADA	TEXTIL/ CUERO
AGUA Y JABON (JABON NEUTRO)	○	○	○	○	○
AGUA COM DETERGENTE		○	○		
MANTENIMIENTO ESPECIFICO DEL FABRICANTE					○

HRVATSKA

UPUTE ZA MONTAŽU:

- 1 > PAŽLJIVO PROČITAJTE UPTE ZA MONTAŽU.
- 2 > PRIPREMITE SVE DIJELOVE NAMJEŠTAJA.
- 3 > PRIKUPITE I PROVJERITE OKOVE ZA MONTAŽU.
- 4 > PRIPREMITE POTREBAN ALAT .
- 5 > PRIPREMITE PROSTOR ZA MONTAŽU.
- 6 > POČNITE MONTIRATI.



**NEMOJTE UPOTREBLJAVATI SILU PRILIKOM SKLAPANJA
NAKON NEKOG VREMENA PONOVRNO PRITEGNITE VIJKE
ČUVAJTE UPUTE ZA MONTAŽU
U SLUČAJU NEDOSTATKA NEKOG DIJELA NAJBOLJE ĆE BITI DA
DA KONTAKIRATE PRODAJNO MJESTO.**

UPUTE ZA ODRŽAVANJE :

- 1 > PAŽLJIVO OBRISATI PRAŠINU.
- 2 > KORISTITE SUHU KRPU.



**- ZABRANJENA JE UPOTREBA
KEMIKALIJA ILI BILO KAKVIH
POMOĆNIH SREDSTAVA ZA RIBANJE
JAKIH SREDSTAV ZA ČIŠĆENJE ILI
ČELIČNE VUNE
-NE MOKRA.**

	PAPIR	LAMINAT	LAK	DRVO	TEKSTIL/ KOŽA
OTPINA SAPUNA	○	○	○	○	○
OTPINA DETERDŽENTA		○	○		
NAMJENSKA SREDSTVA					○

TÜRÇE

MONTAJ TALIMATLARI:

- 1 > MONTAJ TANITIM YAZISINI DIKKATLICE OKUYUNUZ .
- 2 > MOBILİYANIZI OLUŞTURAN PARÇALARI İŞARETLEYİNİZ.
- 3 > HIRDAVATLA İLGİLİ PARÇALARI BİR ARAYA TOPLAYIP; KONTROL EDİNİZ.
- 4 > GEREKEN ARAÇ VE GEREÇİ TEDARİK EDİNİZ.
- 5 > (KENDİNİZE) BİR MONTAJ ALANI EDİNİNİZ.
- 6 > MONTE ETMEYE BAŞLAYINIZ.



MONTAJLARI ZORLAMAYINIZ.
BİRKAÇ KULLANIMDAN SONRA VIDALARI SIKIŞTIRINIZ.
BİR PARÇANIN KAYBOLMASI DURUMUNDA MAGAZANIZLADAKİ
KOLAY İLETİŞİME GEÇEBİLMENİZ İÇİN MONTAJ KULLANIM
TALIMATINIZI SAKLAYINIZ.

BAKIM TALIMATLARI:

- 1 > TOZUNU DIKKATLICE ALINIZ.
- 2 > YUMUŞAK BİR BEZİ TEMİZ SU VE AZ MİKTARDA SABUNLA(DETERJAN) NEMLENDİRİNİZ.



ASLA AŞINDIRICI ÜRÜNLER
KULLANMAYINIZ : ÇELİK YÜNÜ,
**SOLVENT...
BOL SUYLA YIKAMAYINIZ.**

	SÜS KAGIDI	KATMAN YÜZEY	LAKE YÜZEY	CILALI TAHTA	TEKSTİL DERİ
SABUNLU SU (NOTR SABUN)	<input type="radio"/>	<input type="radio"/>	<input type="radio"/>	<input type="radio"/>	<input type="radio"/>
DETERJAN KATILMIŞ SU		<input type="radio"/>	<input type="radio"/>		
ÜRETİCİYE ÖZGÜ BAKIM					<input type="radio"/>

ENGLISH

ASSEMBLY ADVICE :

- 1 > CAREFULLY READ THE ASSEMBLY INSTRUCTION.
- 2 > IDENTIFY THE COMPONENTS OF THE FURNITURE.
- 3 > GROUP AND CHECK THE HARDWARE.
- 4 > USE THE REQUIRED TOOLS.
- 5 > CREATE AN ASSEMBLY ZONE.
- 6 > MAKE THE ASSEMBLY.



NEVER FORCE THE CONNECTIONS.
RE-TIGHTEN THE SCREWS AFTER FEW DAYS.
PLEASE RETAIN THE AI LEAFLET FOR FUTURE REFERENCE,
THE AI CONTAINS INFORMATION WHEN CLAIMING
FOR MISSING PARTS.

CLEANING ADVICE:

- 1 > CAREFULLY REMOVE THE DUST.
- 2 > USE A SOFT, CLEAN DAMP CLOTH WITH SOAPY WATER.



NEVER USE ABRASIVE PRODUCTS
OR SOLVENTS.
DO NOT APPLY EXCESSIVE PRESSURE
WHEN USING THE DAMP CLOTH.

	PAPER DECOR	LAMINATED SURFACES	LACQUERED SURFACE	VARNISHED WOOD	LEATHER TEXTILE
SOAPY WATER (NEUTRAL SOAP)	<input type="radio"/>	<input type="radio"/>	<input type="radio"/>	<input type="radio"/>	<input type="radio"/>
WATER WITH DETERGENT		<input type="radio"/>	<input type="radio"/>		
SPECIFIC SUPPLIER CLEANING					<input type="radio"/>

PENSEZ AU TRI !
ENSEMBLE RÉDUISONS
L'IMPACT ENVIRONNEMENTAL
DES EMBALLAGES

**ÉLÉMENT(S)
PLASTIQUE(S)**

À JETER

**ÉLÉMENT(S)
MÉTAL(S)
CARTON(S) PAPIER(S)**

À RECYCLER



CONSIGNE POUVANT VARIER LOCALEMENT > WWW.CONSIGNESDETRI.FR