

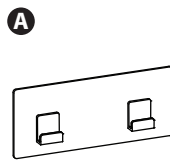

CUBIKO
 Corner Bins, Set of 2
 Corbeille d'angle, lot de 2
 Bandeja esquinera, juego de 2
 Eckbehälter, 2er-set
 Porta-acessórios, conjunto de 2
 Contenitore angolare, set di 2
 Design/Diseño: Umbra Studio
 umbra.com

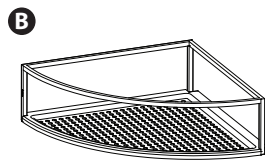

x4



x2



x4



x1

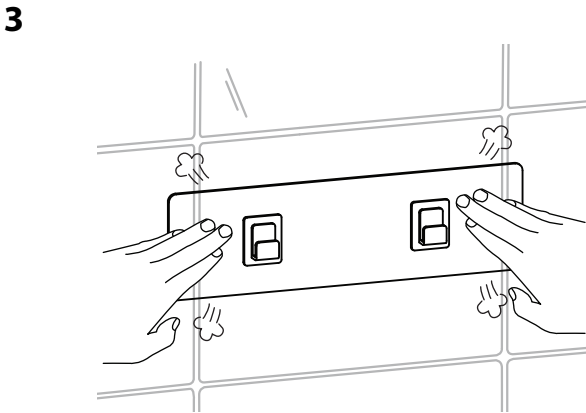
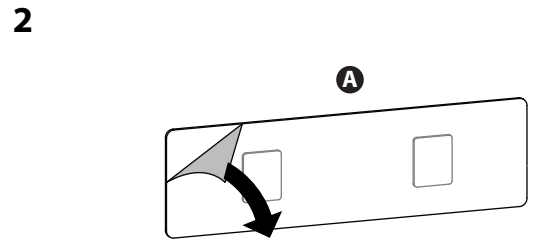
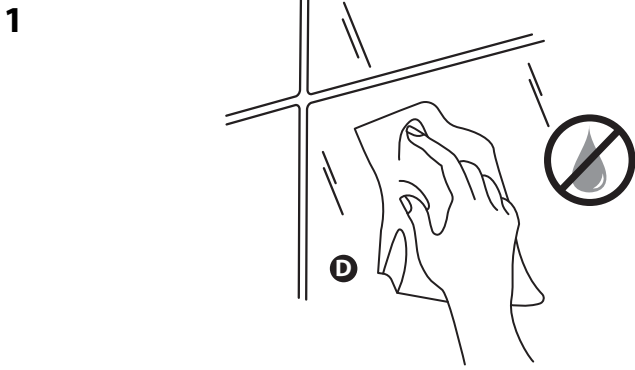

Tiles/Glass
Carrelage/Verre

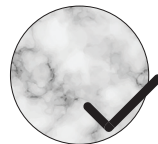

Marble
Marbre



Stainless Steel
Acier inoxydable



Rough Surface
Surface texturée



Painted Wall
Mur peint



Wallpaper
Papier peint

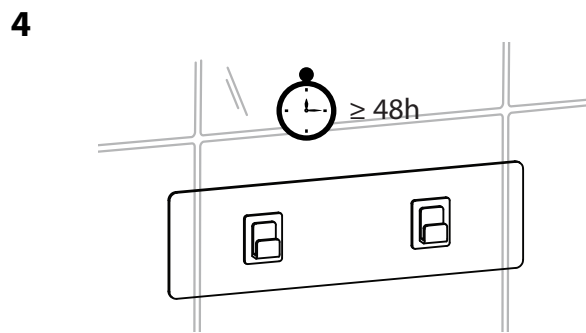

Transparent adhesive must be mounted on smooth, non-porous surfaces like stainless steel, porcelain, tile, etc. Not for use on textured surfaces such as quartz & stone.

L'adhésif transparent doit être monté sur une surface lisse et non-poreuse comme l'acier, la porcelaine, le carrelage, etc. Ne pas utiliser sur une surface texturée tel le quartz ou la pierre.

El adhesivo transparente debe montarse en superficies lisas y no porosas como acero inoxidable, porcelana, baldosas, etc. No debe usarse en superficies texturizadas como cuarzo y piedra.

Transparente Klebefläche muss auf glatten, nicht porösen Oberflächen wie Edelstahl, Porzellan, Fliesen etc. angebracht werden. Nicht für raue Oberflächen wie Quarz und Stein geeignet.

O adesivo transparente deve ser montado em superfícies lisas e não porosas como aço inoxidável, porcelana, azulejos, etc. Não deve ser usado em superfícies texturizadas como quartzo e pedra.

L'adesivo trasparente deve essere montato su superfici lisce e non porose come acciaio inossidabile, porcellana, piastrelle, ecc. Non utilizzare su superfici testurizzate come quarzo e pietra.

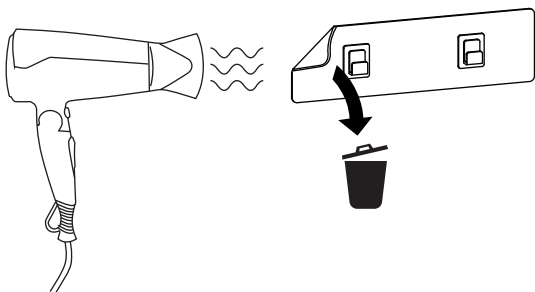
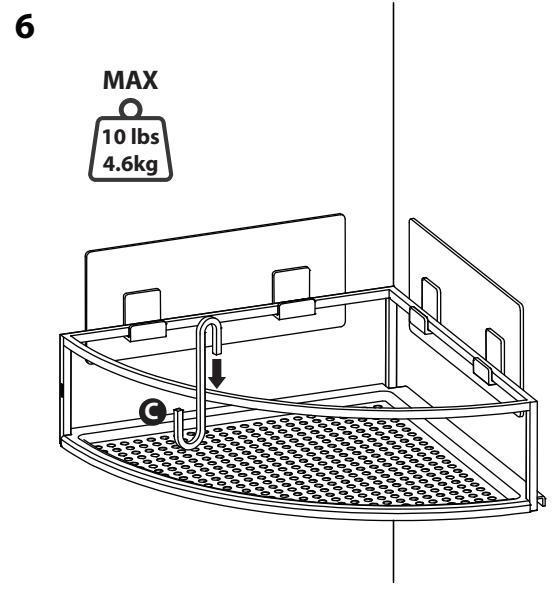
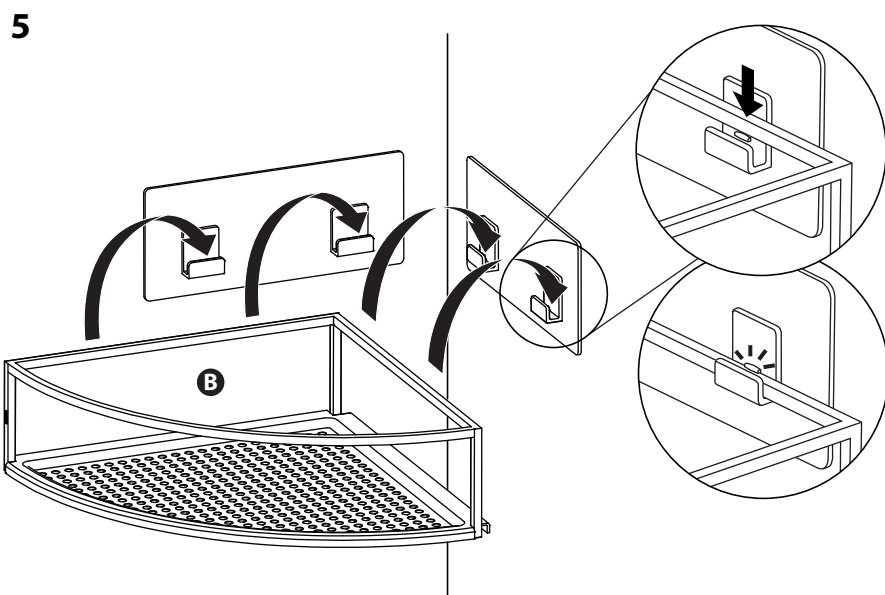

If you need to remove the installed adhesive, you can use a hair dryer to heat the adhesive surface and slowly separate from mounting surface.

Si vous devez retirer l'adhésif installé, vous pouvez utiliser un sèche-cheveux pour chauffer la surface adhésive et la séparer doucement du mur.

Si necesita quitar el adhesivo instalado, puede usar un secador de pelo para calentar la superficie adhesiva y separarla lentamente de la superficie de montaje.

Wenn Sie den Klebestreifen entfernen müssen, können Sie diesen mit einem Fön erwärmen und langsam von der Klebefläche abziehen.

Se precisar remover o adesivo instalado, você pode usar um secador de cabelo para aquecer a superfície adesiva e separá-la lentamente da superfície de montagem.

Se hai bisogno di rimuovere l'adesivo applicato, puoi utilizzare un asciugacapelli per riscaldare la superficie dell'adesivo e quindi rimuoverlo.