



Express Essential
Express Easy

EN

Summary

USING YOUR APPLIANCE	6
1.1 Getting started.....	6
1.2 Filling the water tank.....	9
1.3 Transportation	10
1.4 Settings.....	11
1.5 Vertical steaming	13
1.6 Auto-off	14
MAINTENANCE AND STORAGE.....	15
2.1 Emptying the calc collector*	15
2.2 Descaling your generator	16
2.3 Cleaning	19
2.4 Storage	20
SAFETY INSTRUCTIONS.....	21
TROUBLESHOOTING.....	27
TEFAL INTERNATIONAL GUARANTEE.....	30

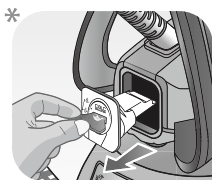
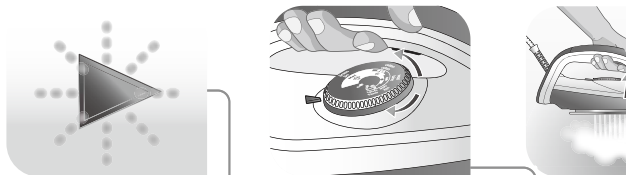

* Depending on the model

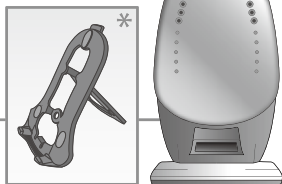
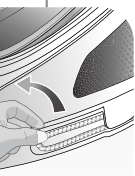
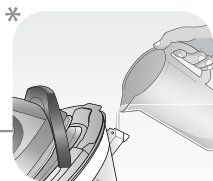
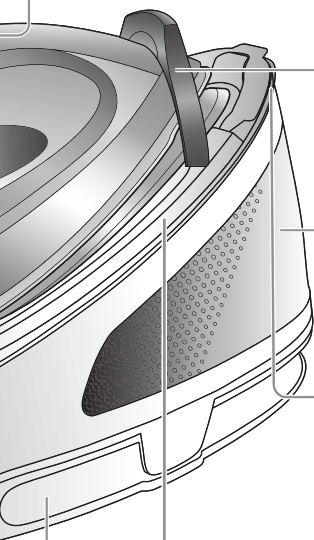
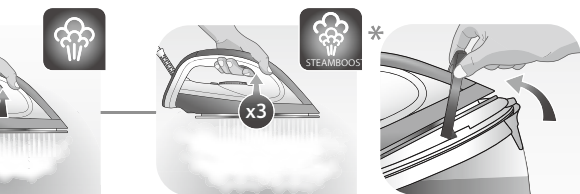

* Depending on model

www.Tefal.co.uk



USING YOUR APPLIANCE

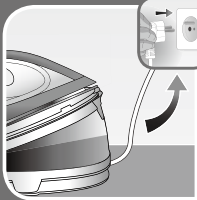

1.1 Getting started

Some models are equipped with a lock system to hold the iron onto the base for easy transport and storage.*

- Unlock your steam generator.*
- Completely unwind the power cord and take the water cord out of its storage space.
- Fill the water tank with tap water up to the max indicator. Put the tank back into the appliance by pushing in until it locks into place.
- If you have a fixed water tank, open the lid and fill it directly with a jug of water.
- Plug in your steam generator.

* Depending on model

USING YOUR APPLIANCE



- Press the «ON-OFF» button on control panel.
- The «ON-OFF» button light remains flashing while the appliance is warming up.

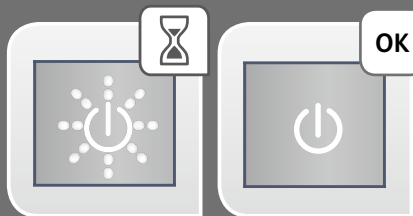

- The ECO mode setting can still be selected at this time.
- When the light stops flashing, the steam generator is ready for use. This can take up to 2 minutes.

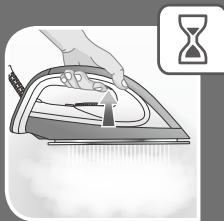

- To release steam, press and hold the steam trigger under the iron handle. The steam will stop when you release the trigger.

USING YOUR APPLIANCE



- To release even more steam, press the steam trigger under the handle three times in quick succession for automatic sequential steam.

*



During ironing do not leave the iron faced down on the soleplate or resting on the flush accessory. For your safety, place the iron on the steam generator base or on its heel.

* Depending on model

USING YOUR APPLIANCE

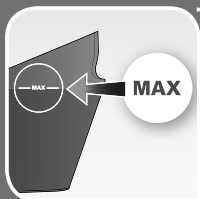
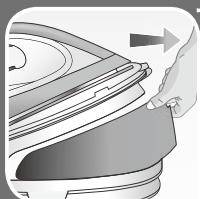

1.2 Filling the water tank*

- Switch off and unplug the appliance.
- Remove the removable water tank using the handle located at the front of the steam generator.
- Fill it with tap water without exceeding the MAX level.
- Push it back into its housing until you hear a «click».
- If you have a fixed water tank, open the lid and fill it directly with a jug of water.

* Depending on model

USING YOUR APPLIANCE



1.3 Transportation*

Your steam generator is equipped with a lock system to hold the iron onto the base for easy transport and storage.

To transport your steam generator using the handle of the iron:

- Put the iron on the steam generator base and lift the lock system over the iron until it locks into place and you hear an audible click.
- Hold the iron by the handle to transport your steam generator.

* Depending on model

USING YOUR APPLIANCE

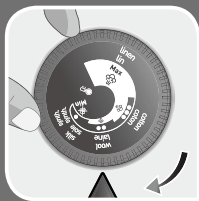

1.4 Settings

Changing modes

- To change the setting use the thermostat that is on the handle of the iron.
- When you use the 'synthetic' or 'wool' settings, the temperature will decrease and no steam is required. Thus there is no need to press the steam trigger.
- When using the 'cotton' or 'linen' setting the temperature will increase and you can use the steam trigger.
- When you press the "ECO" button, temperature and steam decrease.

* Except for SV6140 where the steam can be used on any mode

USING YOUR APPLIANCE



- To turn off 'ECO' setting, press the ECO button again. The temperature and steam will increase.

USING YOUR APPLIANCE

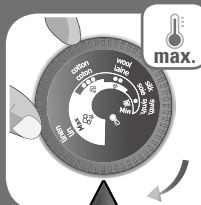

1.5 Vertical steaming

As steam is very hot: never attempt to remove creases from a garment while it is being worn, always hang garments on a coat hanger.

- Hang the garment on a coat hanger and hold the fabric slightly taut with one hand.
- Holding the iron in a vertical position tilted slightly forwards, press on the steam trigger (underneath the iron handle) moving the iron from top to bottom.
- Always use the 'max' setting on the thermostat for vertical steaming.

USING YOUR APPLIANCE



1.6 Auto-off

- The steam generator is fitted with an "AUTO-OFF" monitoring system. After approximately 38 minutes of non-use, the «AUTO-OFF» system switches off your steam generator.
- To start your ironing again, press the «ON-OFF» button and you will hear a beep.

MAINTENANCE AND STORAGE

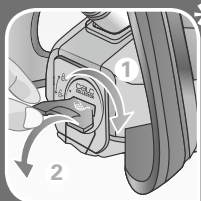
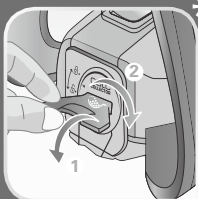

2.1 Emptying the scale collector*

- For long lasting steam performance, empty the scale collector every now and then.
- Switch off and unplug the appliance.

Appliance must be completely cooled down and unplugged for at least an hour before emptying the scale collector.

- Fully unlock the collector and pull it out of the base unit.

Do not use your steam generator without reinserting the scale collector.

* Depending on model

MAINTENANCE AND STORAGE

2.2 Descaling your generator

- The flashing 'anti calc' indicator alerts you when descaling is required.
- Switch off the unit by pressing the «Off» button, then unplug the appliance and allow it to cool completely.
- Move the unit over a sink and fill the water tank.
- Detach the removable stand from the base of the appliance.*
- Set down the stand near the sink and place the iron on top.*
- Put the water tank back in the base.
- Plug in the appliance and switch it on by pressing the «On» button.

OFF

Anti-calc

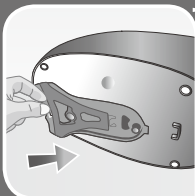
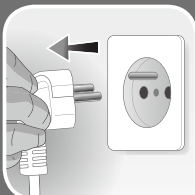

CLICK

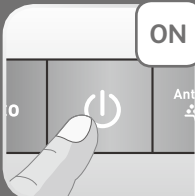
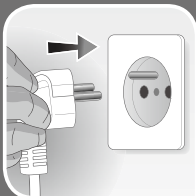

* Depending on model

MAINTENANCE AND STORAGE

3
sec

Anti-calc

2
MIN



2 mins

 beep
OFF



- If you do not have the model with the removable stand, then hold your iron above the sink.

- Press the blinking «Anti calc» button for 3 seconds.

- The descaling process is performed, during which the iron will emit water and steam for 2 minutes. Beware of the iron's heat during the descaling cycle.

- An audio signal (long beep) sounds at the end of the descaling cycle.

- Your steam generator will shut down automatically. You must then unplug the steam generator and allow it to cool.

- Unlock and remove the scale collector in the back of the iron to rinse it.*

- Next, reposition the collector, as well as the removable stand.*

MAINTENANCE AND STORAGE

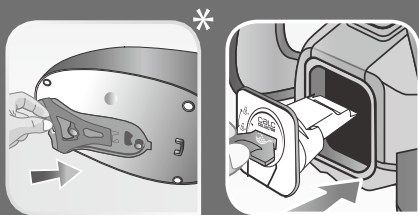

- Please make sure to empty the water tank before replacing the removable stand in the back of the iron.

* Depending on model

MAINTENANCE AND STORAGE



2.3 Cleaning

Appliance must be completely cooled down and unplugged for at least 2 hours before emptying the scale collector.

- Clean soleplate with a soft damp cloth.

Do not use detergent or descaling products for cleaning the soleplate.

- Clean the plastic parts of the appliance occasionally with a soft cloth.

Never hold the iron or the base unit under the tap.

MAINTENANCE AND STORAGE

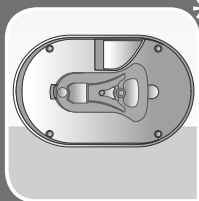
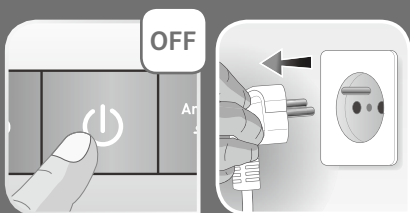

2.4 Storage

- Switch off and unplug the appliance.
- Store the steam cord in its side storage place without stretching it too much.
- Store the flush accessory in its holder underneath the appliance.*
- Leave the steam generator to cool (around 1h) then empty the water tank before putting it away if you are storing it in a cupboard or a confined space.

If you store your steam generator in a relatively cold place (approximately <math><10^{\circ}\text{C}</math>), put it in a warm place before starting your ironing.

* Depending on model

Important recommendations

- Please read these instructions carefully before first use. This product has been designed for domestic indoor use only. Any commercial use, inappropriate use or failure to comply with the instructions, the manufacturer accepts no responsibility and the guarantee will not apply.
- Never unplug the appliance by pulling the power cord. Always unplug your appliance:
 - before filling the water tank.
 - before cleaning the appliance,
 - after each use.
- The appliance must be used and placed on a flat, stable, heat-resistant surface. When you place the iron on the iron rest, make sure that the surface on which you place it is stable.
- This appliance is not intended to be used by persons (including children) with reduced or impaired physical, sensory or mental capabilities or persons lacking appropriate knowledge or experience, unless a person responsible for their safety provides either supervision or appropriate instructions concerning use of the appliance prior to its use.
- Children should be supervised to ensure they do not play with the appliance.
- This appliance may be used by children aged 8 or over and persons lacking appropriate knowledge or experience or persons with reduced or impaired

physical, sensory or mental capabilities provided that they have been thoroughly instructed regarding the use of the appliance, are supervised, and understand the risks involved. Children shall not play with the appliance. Cleaning and user maintenance shall not be made by children without supervision. Keep the iron and its cord out of reach of children less than 8 years of age when it is energized or cooling down.

-  The surfaces of your appliance marked by this symbol can reach very high temperatures when functioning, which may cause burns. Do not touch the hot surfaces of the appliance (accessible metal parts and plastic parts adjacent to the metallic parts) until the appliance has completely cooled.
- Never leave the appliance unattended when it is connected to the mains. Before storing the appliance, once it is unplugged, please wait until it has cooled down (around 1 hour).
- Never fill your appliance directly from the tap.
- The cartridge cap must not be opened during use.
- The appliance must not be used if it has been dropped, if it has any visible damage, if it leaks, or if it functions abnormally in any way. Do not attempt to dismantle your appliance: have it examined at an Approved Service Centre to avoid any danger.
- Check the electrical power and water connection cords for signs of wear or damage prior to use. If the electrical power cord or the water connection cord is damaged, it must be replaced by an Approved Service Centre to avoid any danger.

- All accessories, consumable goods and spare parts must be purchased exclusively from an Authorised Service Centre.
- For your safety, this device complies with applicable standards and regulations (Low Voltage Directives, Electromagnetic Compatibility, Environment, etc.)
- Your appliance is an electrical appliance: it must be used under normal conditions of use.
- It is equipped with a thermal fuse to avoid overheating.
- Always plug your steam generator:
 - Into an electrical system whose voltage is between 220 and 240 V.
 - Into an earthed electrical outlet.
- Any connection error may cause irreversible damage and invalidates the guarantee. If you use an extension cord, ensure that it is in good condition, has a plug with an earth connection and is suited to the power rating of the appliance.

Important notice for $\geq 2800W$ models only :

Under unfavourable conditions, phenomena such as transient voltage drops or lighting fluctuations may occur. Therefore it is recommended to plug the iron into a power supply with a maximum impedance of $0,30 \Omega$. If necessary, the user can contact the electricity supplier for further information about the system impedance at the interface point.

- Fully unwind the electrical cord and plug it into an earthed electrical outlet.
- Do not leave the power or water connection cords close to or in contact with sources of heat or sharp edges.

- The sole plate of your iron and the iron rest on the base unit can reach extremely high temperatures, and can cause burns: do not touch them. Never touch the electrical power cords with the sole plate of the iron.
- Always ensure that the base unit is positioned close enough to the ironing surface to avoid straining and premature wear of the water connection cord.
- Always use a vented/mesh ironing board to prevent water spots on clothes and to avoid hot steam venting sideways. Be careful of hot steam when ironing close to the edges of the board.
- Your appliance produces steam which may cause burns.
 - Handle the iron carefully, especially when ironing vertically.
 - Never iron a piece of clothing while it is worn by a person, but always when it is on a hanger.
 - Never iron while in a sitting position with one's legs under the ironing board.
 - Never point the steam at people or animals.
- Never immerse your appliance in water or any other liquid. Never place it under a running tap.
-  During first use, your appliance may give off smoke, an odour or a discharge of particles, but this is normal, is not harmful and will disappear. If you use the appliance for the first time, if you have replaced the anti calc cartridge or after filling the water tank, press the steam control button continuously for few minutes pointing it away from your linen, in order to prime the pump and obtain steam.

- When in use, your electric pump injects water into the iron soleplate. It makes a noise but this is normal.
- Safety Instructions for the Anti-Scale Cartridge and the Collector (Depending on Model):



- Not for drinking



- Keep out of the reach of children



- Dispose with household refuse



- Keep in cool dry place

- Prior to rinsing the collector (depending on the model), always wait until the appliance is cool and unplugged for over an hour to unscrew the collector. To perform this operation, the product must be near a sink, since some water may flow out when opening it.

- Never operate the appliance without the scale collector.

- Never fill the iron using the collector's opening.

- Always iron on the same level as the appliance so as to not strain the cord. Do not place the appliance on a lower level or on the floor.

Preparation

What water may be used ?

- This appliance has been designed to be used with untreated tap water.
- Types of water not to use: In order to prolong your appliance life, you should not use water from clothes dryers, scented or softened water containing additives, water from refrigerators, batteries, air conditioners, rain water, boiled, filtered or bottled water. Do not use pure distilled nor pure demineralised water.
- All the type of water listed above may contain organic waste, mineral or chemical elements that can cause

spitting, brown staining or premature wear of the appliance.

- Do not fill the water tank from the cartridge compartment.
- Empty the water tank after every use. Do not store the steam generator with water in the water tank.

Semi-automatic self-cleaning procedure*

- Never start the self-cleaning procedure when the appliance is on its base.
- Always place the iron on its cleaning stand, over a sink.
- Ensure that the scale collector* is installed in the iron and properly locked, prior to starting self-cleaning.
- Never touch the iron or its cleaning stand during self-cleaning. The cleaning accessory may still be hot; wait at least 15 minutes before handling it.
- The cleaning stand is only intended for self-cleaning.
- Never use this accessory as an iron holder during normal use.



*depending on the model

PLEASE RETAIN THIS INSTRUCTION BOOKLET FOR FUTURE REFERENCE

Environment protection first !



- ① Your appliance contains valuable materials which can be recovered or recycled.

➡ Leave it at a civic waste disposal centre.

TROUBLESHOOTING

Problem	Possible Causes	Solutions
Your iron is producing little or no steam.	You have just filled the tank or changed the anti-calc cartridge, or you have just started using it.	Press the steam control button continuously for few minutes pointing it away from your linen, in order to prime the pump.
	There is no anti calc cartridge in the appliance or it is not properly installed.	Make sure the anticalc cartridge is installed and locked in its compartment.
	Steam cannot be produced at the temperature you have selected.	Set the thermostat control in the coloured zone (••• or MAX).
	The water tank is empty.	Fill the tank.
Water runs out of the holes of the soleplate.	You are using steam for the first time or you have not used it for some time.	Press on the steam control button away from your ironing board until the iron produces steam.
	The setting is not correct (1 dot / 2 dots) and the soleplate is not hot enough to produce steam.	Set the iron at 3 dots (••• or MAX) and wait for the iron thermostat light to go out before activating the steam button again.
	You are performing the Anti calc procedure.	It is normal that water runs out of the holes of the soleplate during Anti calc procedure.

Problem	Possible Causes	Solutions
Water streaks appear on the linen.	Your ironing board is saturated with water because it is not suitable for use with an appliance.	Check that your ironing board is suitable. We recommend that you use a vented/mesh type ironing board.
Brown streaks come through the holes in the soleplate and stain the linen.	You are using chemical descaling agents or additives in the water ironing.	Never add this type of product in the water tank (see "for what water may be used"). Contact an Approved Service Centre.
The soleplate is dirty or brown and may stain the linen.	You are ironing at too high a temperature.	See our recommendations regarding temperature control setting.
The "anti calc" indicator is flashing*.	The anti calc cartridge is no longer efficient.	Replace the anti scale cartridge with a new one then press the reset button for a minimum of 3 seconds.
	The descaling procedure must be performed.	See section "Descaling your generator." In this manual to perform the descaling procedure.

Problem	Possible Causes	Solutions
The anti calc indicator is still flashing after replacing the cartridge.	You have not pressed the reset button.	Press the reset button until the light stops flashing.
The anti calc indicator is still flashing after performing the descaling procedure.	The descaling procedure has not been correctly done.	See section "descaling your generator".

* Depending on the model

If you have any problems or queries please call our Customer Relations team first for expert help and advice

TEFAL INTERNATIONAL GUARANTEE

Date of purchase

.....

Retailer name and address

.....

Product reference

.....

.....

.....

Distributor stamp

TEFAL/T-FAL* INTERNATIONAL LIMITED GUARANTEE

 : www.tefal.com

This product is repairable by TEFAL/T-FAL*, during and after the guarantee period.

Accessories, consumables and end-user replaceable parts can be purchased, if locally available, as described on the TEFAL/T-FAL internet site www.tefal.com

The Guarantee:** TEFAL/T-FAL guarantees this product against any manufacturing defect in materials or workmanship during the guarantee period within those countries*** as stated in the attached country list, starting from the initial date of purchase or delivery date. The international manufacturer's guarantee covers all costs related to restoring the proven defective product so that it conforms to its original specifications, through the repair or replacement of any defective part and the necessary labour. At TEFAL/T-FAL's choice, an equivalent or superior replacement product may be provided instead of repairing a defective product. TEFAL/T-FAL's sole obligation and your exclusive resolution under this guarantee are limited to such repair or replacement.

Conditions & Exclusions : TEFAL/T-FAL shall not be obliged to repair or replace any product which is not accompanied by a valid proof of purchase. The product can be taken directly in person or must be adequately packaged and returned, by recorded delivery (or equivalent method of postage), to a TEFAL/T-FAL authorised service centre. Full address details for each country's authorised service centres are listed on TEFAL/T-FAL website (www.tefal.com) or by calling the appropriate consumer Service centre set out in the attached country list. In order to offer the best possible after-sales service and constantly improve customer satisfaction, TEFAL/T-FAL may send a satisfaction survey to all customers who have had their product repaired or exchanged in a TEFAL/T-FAL authorised service centre.

This guarantee applies only for products purchased and used for domestic purposes and will not cover any damage which occurs as a result of misuse, negligence, failure to follow TEFAL/T-FAL instructions, or a modification or unauthorised repair of the product, faulty packaging by the owner or mishandling by any carrier. It also does not cover normal wear and tear, maintenance or replacement of consumable parts, or the following:

- using the wrong type of water or consumable - mechanical damages, overloading
- ingress of water, dust or insects into the product (excluding appliances with features specifically designed for insects)
- damage as a result of lightning or power surges - scaling (any de-scaling must be carried out according to the instructions for use)

- accidents including fire, flood, etc - damage to any glass or porcelain ware in the product
- professional or commercial use - damages or poor results specifically due to wrong voltage or frequency as stamped on the product ID or specification

Consumer Statutory Rights : This international TEFAL/T-FAL guarantee does not affect the Statutory Rights a consumer may have or those rights that cannot be excluded or limited, nor rights against the retailer from which the consumer purchased the product. This guarantee gives a consumer specific legal rights, and the consumer may also have other legal rights which vary from State to State or Country to Country. The consumer may assert any such rights at his sole discretion.

***Where a product purchased in a listed country and then used in another listed country, the international TEFAL/T-FAL guarantee duration is the period for the country of usage, even if the product was purchased in a listed country with a longer guarantee duration. The repair process may require a longer time if the product is not locally sold by TEFAL/T-FAL in the country of usage.

If the product is not repairable in the new country of usage, the international TEFAL/T-FAL guarantee is limited to a replacement by a similar or alternative product at similar cost, where possible.

*TEFAL household appliances appear under the T-FAL brand in some territories like America and Japan. TEFAL/T-FAL are registered trademarks of Groupe SEB.

Please keep this document for your reference should you wish to make a claim under the guarantee.

****For Australia only:**

Our goods come with guarantees that cannot be excluded under the Australian Consumer Law. You are entitled to a replacement or refund for a major failure and compensation for any other reasonably foreseeable loss or damage. You are also entitled to have the goods repaired or replaced if the goods fail to be of acceptable quality and the failure does not amount to a major failure.

****For India only:** Your Tefal product is guaranteed for 2 years. The guarantee covers exclusively the repair of a defective product, but at TEFAL's choice, a replacement product may be provided instead of repairing a defective product. It is mandatory that the consumer, to have his product repaired, has to log a service request on the dedicated Smartphone application TEFAL SERVICE APP or by calling TEFAL Consumer Care Center at **1860-200-1232, Opening hours Mon-Sat 09 AM to 06 PM**. Products returned by Post will not be covered by the guarantee. As a proof of purchase consumer needs to provide both this stamped guarantee card and cash memo.

